

VICKERS® SystemStak® Valves



ISO 4401-03; NFPA-D03; 315 bar (4500 psi); 60 L/min (15.7 USgpm)

Build a Compact, Cost-Effective, Reliable Hydraulic System with Vickers SystemStak™ Valves

Reduces System Space Requirements

SystemStak valves make compact hydraulic systems in which specific function valves are “sandwich” mounted between a directional valve and a standard mounting surface.

Reduce Cost

SystemStak valves eliminate intervalve piping and leak-prone tube and pipe connections. Installed cost is less than when using conventional valves.

Versatile and Easy to Install

SystemStak valves have all the internal passages necessary to serve the directional valve topping them. Mounting surfaces and port patterns are to international standards: any valve conforming to ISO 4401 size 03; ANSI/B93.7M size D03; NFPA-D03; CETOP 3; and DIN 24340, NG6 mounting interface can be used with these SystemStak valves.

Rugged and Reliable

Internal working parts are produced from hardened steel and mounted in ductile (spheroidal graphite) iron bodies. Excellent reliability is ensured. Working parts are accessible without removing valves from an assembled stack.

SystemStak Systems... Easy to Understand, Easy to Design

SystemStak circuitry is best shown using slightly different symbols than those for traditional valve configurations. Each SystemStak symbol has the same basic form and size as shown in fig. 1.

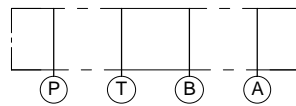

Figure 1

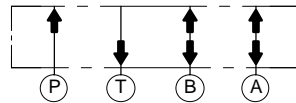

Figure 2

For ease of understanding, remember the directions of flow for each line, and that all four flow paths pass through each valve (see fig. 2). For clarity, directional valves are drawn vertically in SystemStak circuit diagrams (see fig. 3).

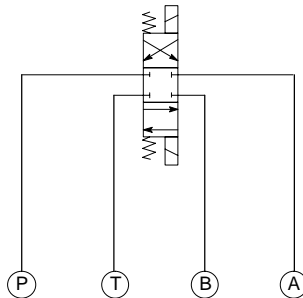

Figure 3

Each station (valve stack) is a combination of functions. When designing and assembling SystemStak valves, care must be taken to ensure that they interact as required by stacking the functions in the correct sequence (fig. 4 is an example).

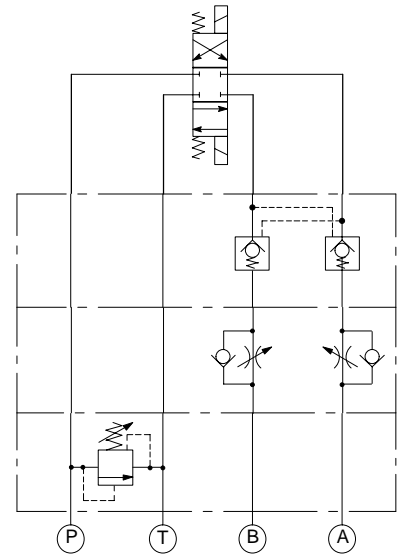

Figure 4

Relief valves should normally be positioned next to the mounting surface (i.e. at the bottom of the stack). When both a flow control and a pilot operated check valve are required, it is recommended that the flow control valve be between the check valve and the actuator to prevent check valve chatter.

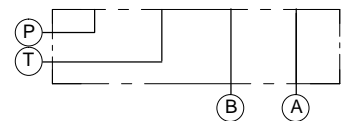

Figure 5

A combination of directional valve, SystemStak valve(s) and subplate/manifold block (fig. 5: single station subplate and fig. 6: multi-station manifold) completes the assembly.

SystemStak Systems . . . Easy to Understand, Easy to Design

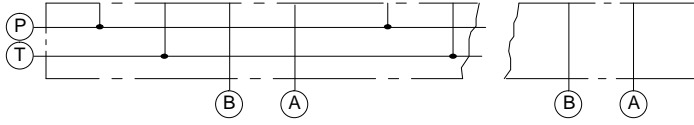

Figure 6

Fig. 7 represents a complete SystemStak system, showing typical use of functions available from this range. The circuit diagram also shows the use of a tapping plate for accessing line pressure readings, and a blanking plate to close off an unused station of a multi-station manifold.

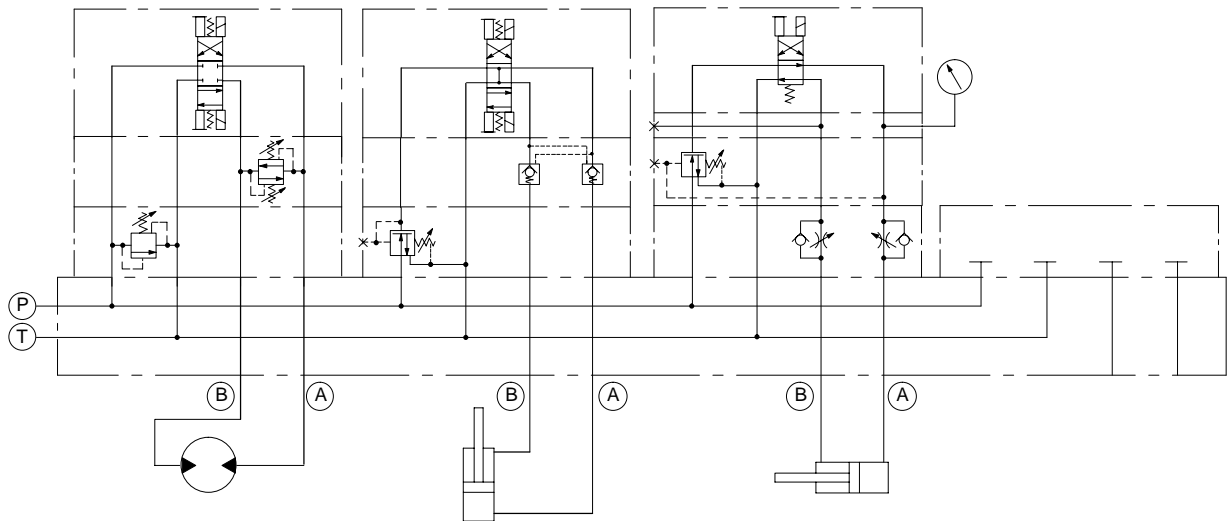

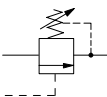
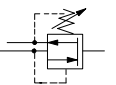
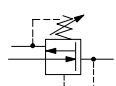

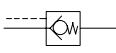
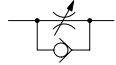

Figure 7

Table of Contents

Function	Basic symbol	Basic model	Features	Page
Relief		DGMC	Single, dual and crossport models	5
Counterbalance		DGMR	Control in port T	9
Sequence		DGMR1	Single port P sequence	9
Reducing/relieving		DGMX	Piloted from (and reduced pressure in) port P, A or B	9
Direct check		DGMDC	Single check in any port; dual check in ports A and B only	13
Pilot operated check		DGMPC	Single in port A or B; dual in ports A and B	16
Flow restrictor		DGMFN	Single or dual port, meter-in or meter-out	19
Further information: Mounting bolts, subplates and manifold blocks Hydraulic fluids Filtration requirements Temperature limits Pressure drop at other viscosities Types H and K adjusters Warranty and repair Ordering procedure				22

Operating Data

Maximum flow rate	60 L/min (16 USgpm)
Maximum operating pressure	315 bar (4500 psi)
Pressure drops	See graphs
Mounting position	Optional

Mass, Approximate:

DGMC	1,3 kg (2.9 lb)
DGMC2	2,5 kg (5.5 lb)
DGMR(1)	1,3 kg (2.9 lb)
DGMX	1,3 kg (2.9 lb)
DGMDC	1 kg (2.2 lb)
DGMPC	0,8 kg (1.8 lb)
DGMFN	1,1 kg (2.2 lb)

Relief Valves

DGMC-3-4*

DGMC2-3-4*

General Description

These two-stage adjustable pressure relief valves limit the maximum pressure in the line(s) controlled by the integral relief valve elements.

Pressure adjustment options of control knob (with or without keylock) or screw/locknut design are available. The two-stage operation is basically identical to long-established balanced piston valves, described in detail in Vickers Industrial hydraulics manual.

Typical Section

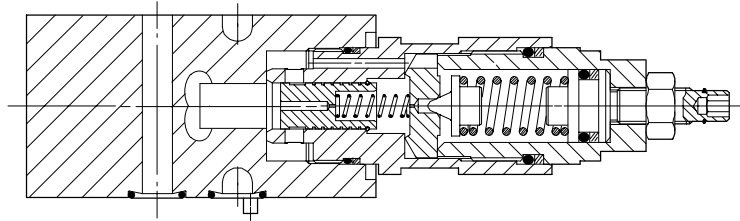

Functional Symbols

For simplicity these two-stage valves are represented as single-stage models

DGMC-3-PT-**

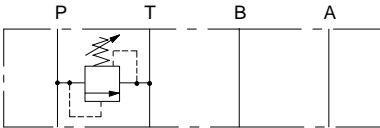

DGMC2-3-AT-**-BT-**

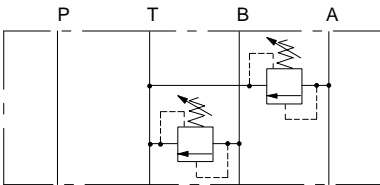

DGMC-3-BA-**

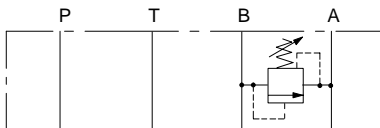

DGMC2-3-AB-**-BA-**

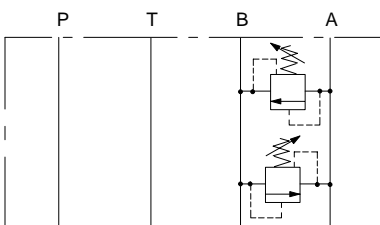

Model Code for Relief Valves

DGMC(2)-3- ** - * * (-B* - * *)- * - 4*

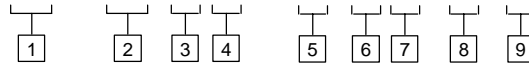

1 Type

2 = Dual relief function
Omit for single relief function

2 First function

Single relief, or first line of dual models

Code	Pressure limited in	Discharge into	Usage
PT	P	T	Single only
AB	A	B	Single, or dual with BA
BA	B	A	Single only
AT	A	T	Single, or dual with BT
BT	B	T	Single only

3 Pressure adjustment range, first function

A = 3-50 bar (43.5-725 psi)
B = 3-100 bar (43.5-1450 psi)
C = 10-200 bar (145-2900 psi)
G = 50-315 bar (725-4500 psi)

4 Pressure adjustment/locking method, first function

H = Handknob
K = Micrometer with keylock
W = Screw and locknut

Relief Valves

DGMC-3-4*

DGMC2-3-4*

5 Second function

Second line of dual models

Code	Pressure limited in	Discharge into	Usage
BA	B	A	Dual with AB
BT	B	T	Dual with AT

Omit for single line models

6 Pressure adjustment range, second function

Options as in 3

7 Pressure adjustment/ locking method, second function

Options as in 4

8 Gage port: option on AT and PT single models only

B = G¹/₄" (1/₄ BSPF)

S = SAE 4 (7/₁₆"-20 UNF-2B)

Blank = No gage port

9 Design number, 40 series

Subject to change. Installation dimensions unchanged for design numbers 40 to 49 inclusive.

Performance Characteristics

Pressure override

Typical performance for PT models at max. pressure settings with mineral oil at 21 cSt (102 SUS) and at 50°C (122°F).

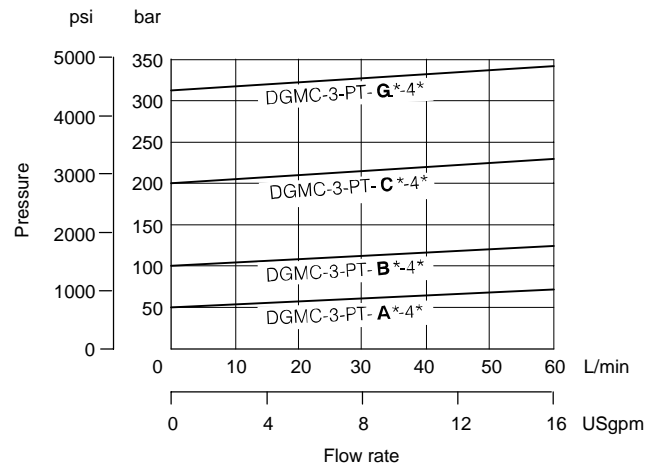

Installation Dimensions in mm (inches)

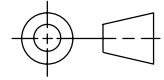

DGMC(2)-3**-**(-B*-**-)-4*

Models with type W adjuster

To adjust valve setting slacken off locknut and turn adjuster screw. ■
 ■ Turn clockwise to increase pressure; counter-clockwise to decrease pressure
 Re-tighten locknut after completing adjustment.

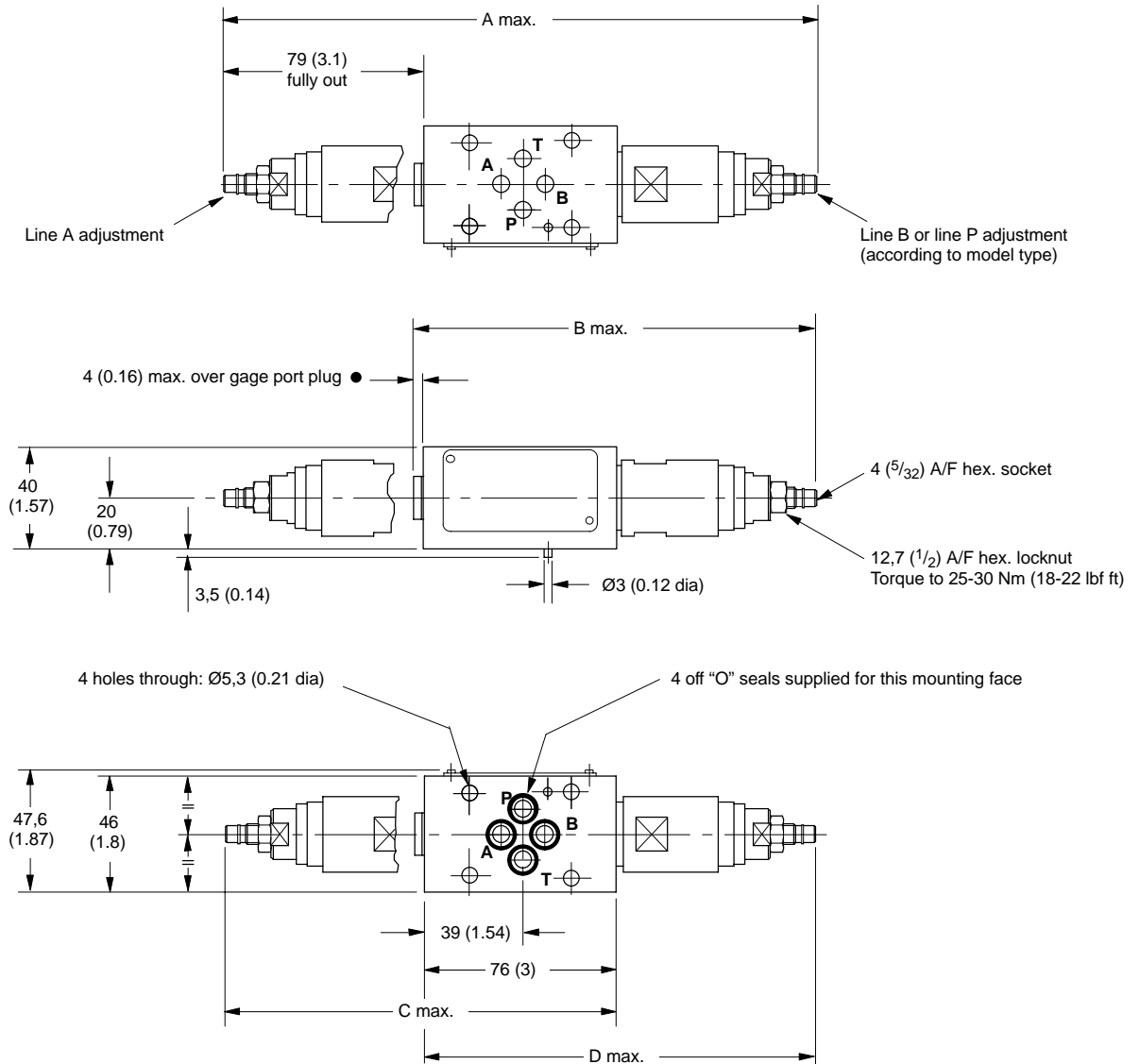

Model	A	B	C	D
DGMC-3-AT-*W-4*	-	-	154 (6.1)	-
DGMC-3-BT-*W-4*	-	-	-	156 (6.2)
DGMC-3-AT-*W-*4*	-	160 (6.3)	-	-
DGMC-3-PT-*W-4*	-	-	-	156 (6.2)
DGMC-3-PT-*W-*4*	-	160 (6.3)	-	-
DGMC2-3-AT-*W-BT-*W-4*	234 (9.2)	-	-	-

● For gage port thread options see model code 8

Installation Dimensions in mm (inches)

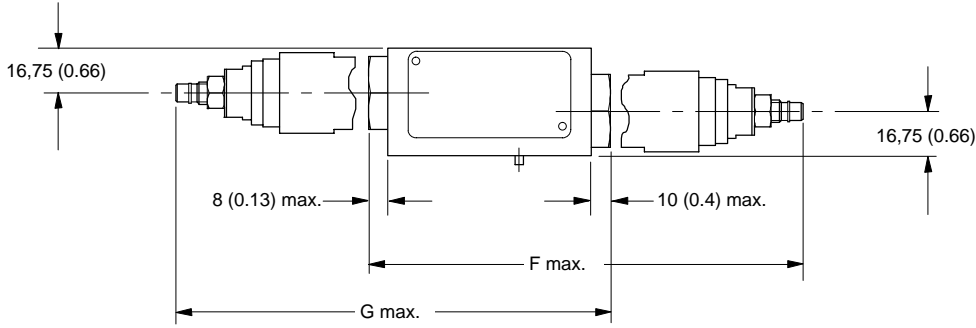
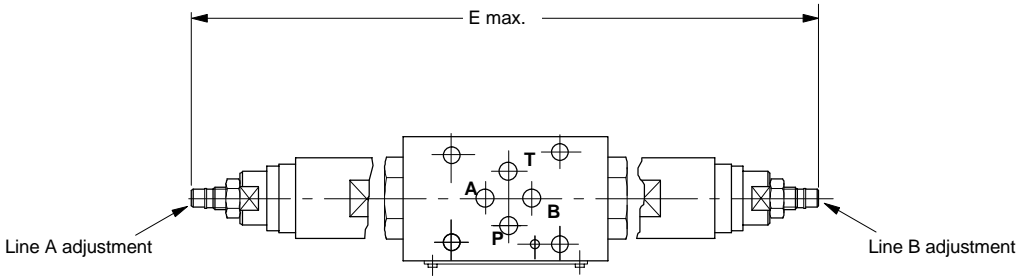

Model	E	F	G
DGMC-3-AB-*W-4*	-	-	164 (6.5)
DGMC-3-BA-*W*-4*	-	164 (6.5)	-
DGMC2-3-AB-*W-BA-*W-4*	234 (9.2)	-	-

Pressure Controls: Counterbalance, Sequence and Pressure Reducing Valves

DGMR(1)-3-4*

DGMX*-3-4*

General Description

These single-stage valves operate by the application of pressure on the end of the valve spool, acting against a spring which is loaded by means of the adjustment mechanism.

In the counterbalance and sequence valves the spool is offset by the spring such that flow cannot pass through the valve. When the force exerted by the pilot pressure on the spool end exceeds the force of the main spring, the spool is moved to allow flow through the valve.

In the pressure reducing valve the flow path is normally open and is closed as the pilot pressure exceeds the setting of the valve. Excessive pressure in the reduced-pressure line is prevented by a pressure relieving function.

Pressure adjustment options of control knob (with or without keylock) or screw/locknut design are available.

Typical Section

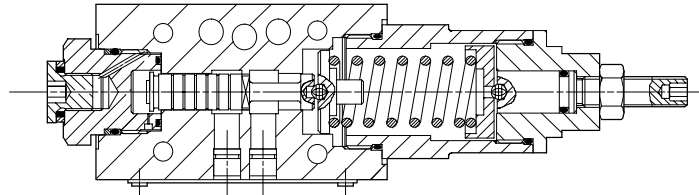

Functional Symbols

DGMR-3-TA

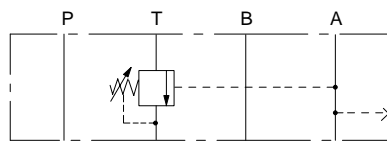

DGMX*-3-PB

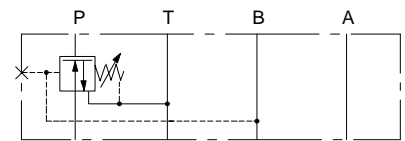

DGMR1-3-PP

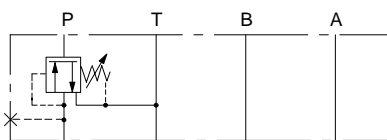

DGMX*-3-PP

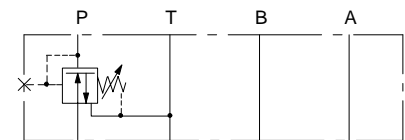

DGMX*-3-PA

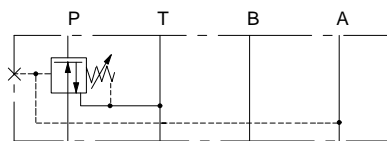

Model Code for Counterbalance, Sequence and Pressure Reducing Valves

DGM *(*) -3- ** (*)- * * - * - 4*

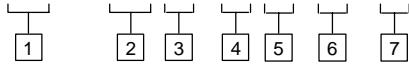

1 Type

R = Counterbalance function
R1 = Sequence function
X1 = Pressure reducing, underlapped
X2 = Pressure reducing, overlapped
X3 = Pressure reducing, overlapped,
low leakage

2 Function ports

For DGMR only:
TA = Counterbalance control function in
“T” port, controlled by pressure in
“A” port
For DGMR1 only:
PP = Sequence control in “P” port,
controlled by pressure in “P” port
For DGMX only:
PA = Pressure reducing function in line
P, piloted from A
PB = Pressure reducing function in line
P, piloted from B
PP = Pressure reducing function in line
P, piloted from P

3 Adjuster location

Option on DGMX only
L = Adjuster at “A”-port end of valve
Blank = Adjuster at “B”-port end of valve

4 Pressure adjustment range

For DGMX only:
Y = 1,40-7,0 bar (21-101 psi)
R = 1,40-45,0 bar (21-652 psi)
For DGMR and DGMX:
A = 3-30 bar (43.5-435 psi)
B = 3,5-70 bar (51-1000 psi)
C = 10-140 bar (145-2000 psi)
F = 20-250 bar (290-3625 psi)

5 Pressure adjustment/ locking method

H = Handknob
K = Micrometer with keylock
W = Screw and locknut

6 Gage port

B = G^{1/8}” (1/8 BSPF)
S = SAE 4 (7/16”-20 UNF-2B)

7 Design number, 40 series

Subject to change. Installation
dimensions unchanged for design
numbers 40 to 49 inclusive.

Performance Characteristics

Typical performance with mineral oil at 21 cSt (102 SUS) and at 50°C (122°F).

DGMX*-3-P*

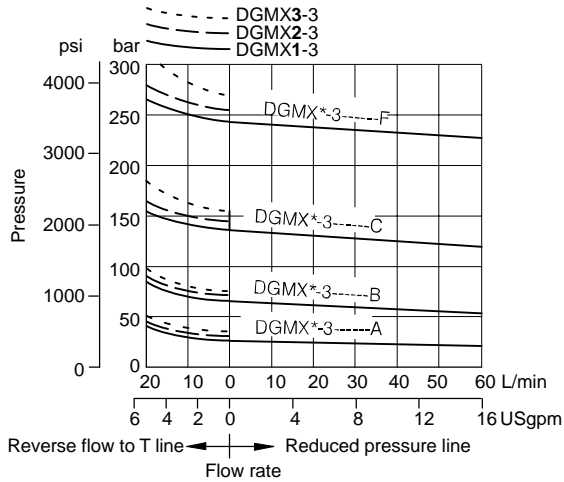

DGMR1-3-PP

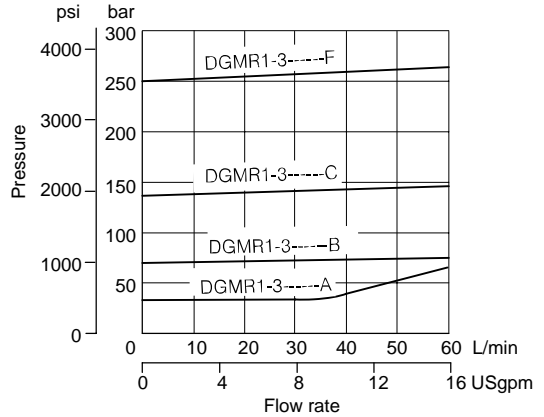

DGMX*-3-P*

Low Pressure/Flow Rate Minimum Performance

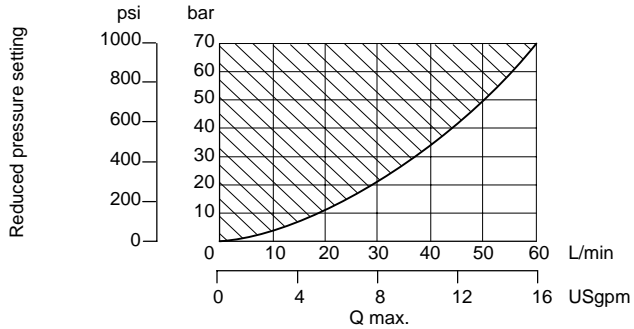

Effect of Back-Pressure

The effective reduced pressure is equal to the valve adjustment setting plus any back-pressure in line T

Dead Head Leakage

Typical leakage flow at 250 bar inlet pressure from reduced pressure line into T at "Dead Head" condition (i.e. No flow required at the reduced pressure outlet.)

This leakage flow must be provided at the inlet line P in order to maintain the reduced outlet pressure.

DGMX1-3 = 1600

DGMX2-3 = 400

DGMX3-3 = 80

Installation Dimensions in mm (inches)

DGMR-3-TA--*-4***
DGMR1-3-PP--*-4***
DGMX(*)-3-P*(L)--*-4***

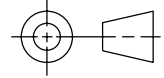

Models with type W adjuster

To adjust valve setting slacken off locknut and turn adjuster screw ■

■ Turn clockwise to increase pressure;
 counter-clockwise to decrease pressure.

Re-tighten locknut after completing adjustment.

DGMX2-3-**L models have adjuster and end cap/gage port locations interchanged from positions shown.

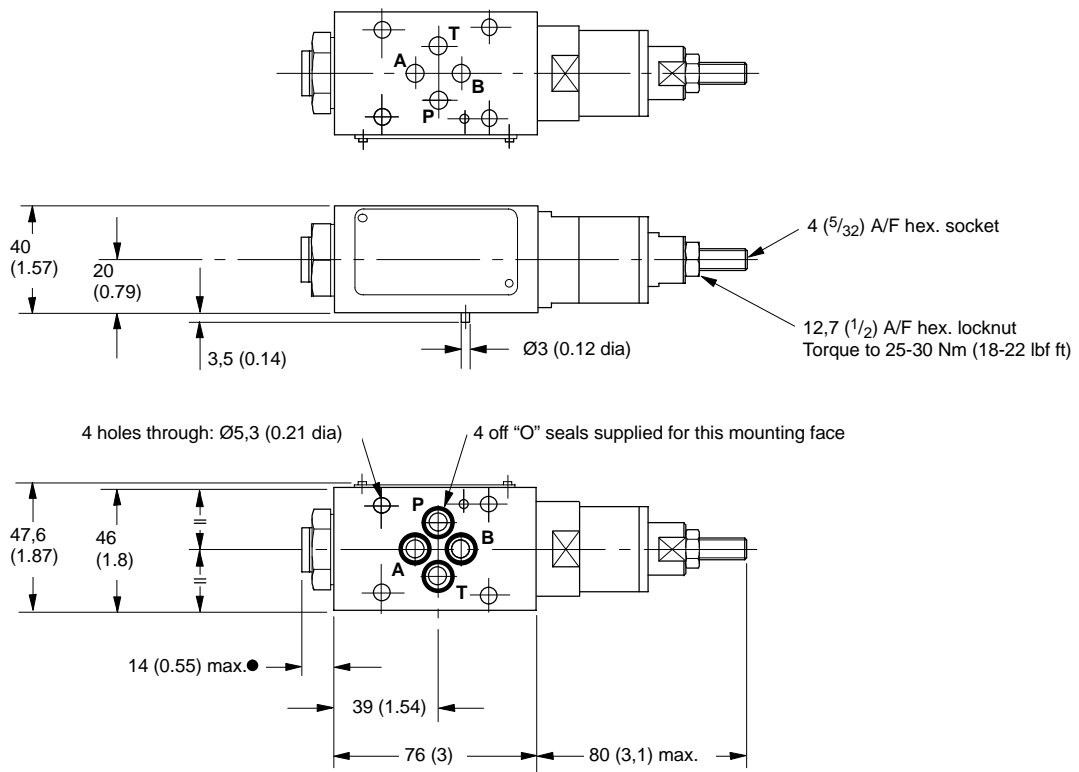

● For gage port thread options see model code [6],
 (pressure plug fitted)

Direct Check Valves

DGMDC-3-4*

General Description

These valves allow free flow in one direction in the line in which the check valve element(s) is (are) located; flow in the opposite direction is not possible.

Functional Symbols

DGMDC-3-X-A*



DGMDC-3-Y-A*

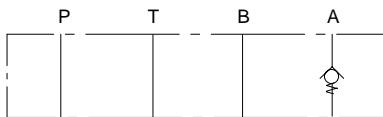

DGMDC-3-X-B*

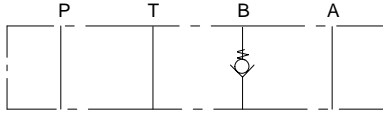

DGMDC-3-Y-B*

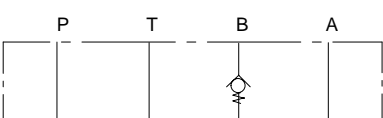

DGMDC-3-Y-P*

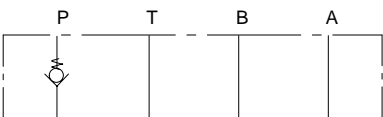

DGMDC-3-X-T*

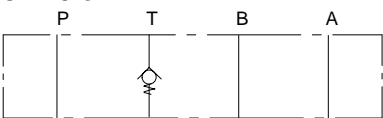

DGMDC-3-Y-A*-B*

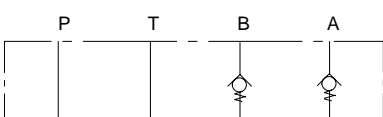

Typical Section

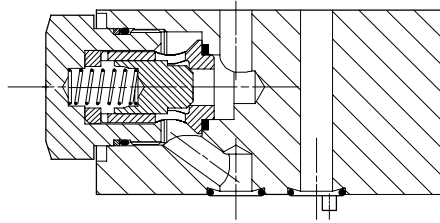

Model Code for Direct Check Valves

DGMDC-3- * - * * (- * *)-4*

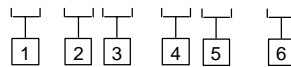

1 Direction of flow

X = Free flow away from actuator

Y = Free flow towards actuator

2 Check location

A = A line

B = B line

P = P line; with Y in 1

T = T line; with X in 1

3 Check valve opening/cracking pressure

K = 1 bar (14.5 psi)

M = 2,5 bar (36 psi)

N = 5 bar (72 psi)

4 Check location (second element of dual model)

Only available as model type

DGMDC-3-Y-A*-B*-4*

B = B line

5 Check valve opening/cracking pressure (second function of dual model)

Options as in 3

6 Design number, 40 series

Subject to change. Installation dimensions unchanged for design numbers 40 to 49 inclusive.

Performance Characteristics

Typical performance with mineral oil at 21 cSt (102 SUS) and at 50°C(122°F) ●

Pressure drop: free flow through check valve

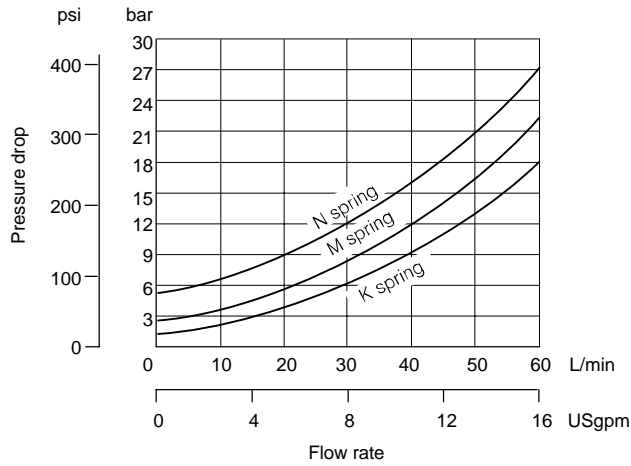

● For other viscosities, see "Further Information".

Internal Leakage Across Closed Check Valve

Less than 0,25 ml/min (0.015 in³/min) at 250 bar (3625 psi)

Installation Dimensions in mm (inches)

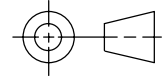

DGMDC-3-Y-A*-B*-4*

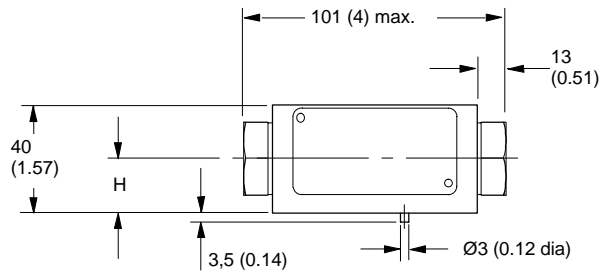
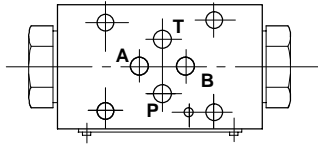

DGMDC-3-X-A*-4*
DGMDC-3-X-T*-4*
DGMDC-3-Y-A*-4*
DGMDC-3-Y-P*-4*

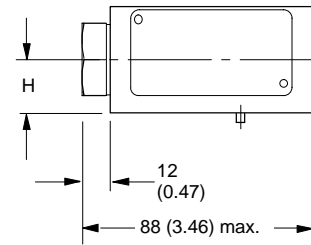
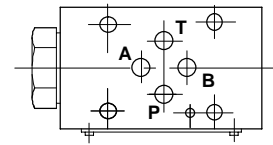

4 holes through: Ø5,3 (0.21 dia)

4 off "O" seals supplied for this mounting face

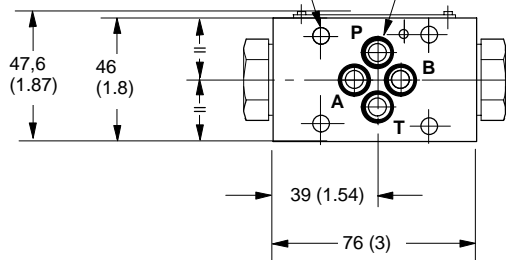

DGMDC-3-X-B*-4*
DGMDC-3-Y-B*-4*

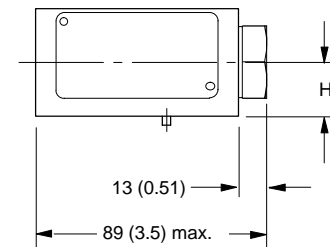

Model type	H
DGMDC-3-X-A*-4*	16,75
DGMDC-3-X-B*-4*	(0.66)
DGMDC-3-Y-P*-4*	
DGMDC-3-X-T*-4*	23,25
DGMDC-3-Y-A*-4*	(0.92)
DGMDC-3-Y-B*-4*	
DGMDC-3-Y-A*-B*-4*	

Pilot Operated Check Valves

DGMPC-3-4*

General Description

These valves provide pilot operated check functions in one or both service lines (A or B), the operating pilot supply coming from the opposite service line. Thus with pressure in one service line the check valve in the other service line will be open (subject to system/actuator pressures being correct for the valve area ratios).

A 3:1 area ratio of pilot piston to check valve seat is supplemented by an optional 10:1 decompression feature.

Typical Section

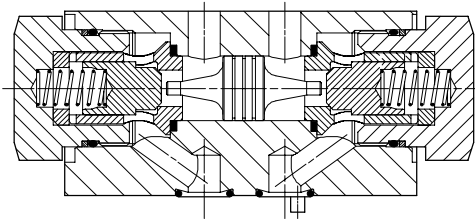

Functional Symbols

DGMPC-3-(D)AB*-(D)BA*

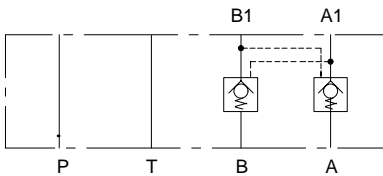

DGMPC-3-(D)AB*

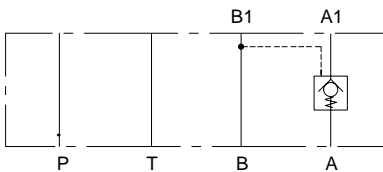

DGMPC-3-(D)BA*

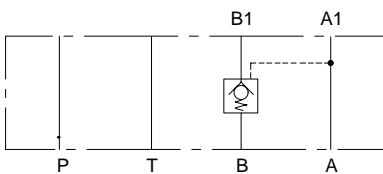

Model Code for Pilot Operated Check Valves

DGMPC-3-(D)** * [-(D)** *]- 4*

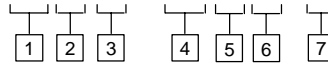

1 Decompression feature

D = 10:1 decompression ratio
Omit if not required

2 Function

AB = Check in line A, pilot operated from line B
BA = Check in line B, pilot operated from line A (single check model only)

3 Check valve opening/cracking pressure

K = 1 bar (14.5 psi)
M = 2,5 bar (36 psi)
N = 5 bar (72 psi)

4 Decompression feature (second function of dual models)

As in 1
Omit for single line models, and if not required for dual models

Note: "D" must be specified here, for dual models, if called for in 1

5 Second function of dual models

BA = Check in line B, pilot operated from line A
Omit for single line models

6 Check valve opening/cracking pressure (second function of dual models)

Options as in 3
Omit for single line models

7 Design number, 40 series

Subject to change. Installation dimensions unchanged for design numbers 40 to 49 inclusive.

Performance Characteristics

Pressure Drop Data

Typical performance with mineral oil at 21 cSt (102 SUS) and at 50°C(122°F) u

Pressure drop: flow path A1 to A or B1 to B (no pilot-pressure operation)

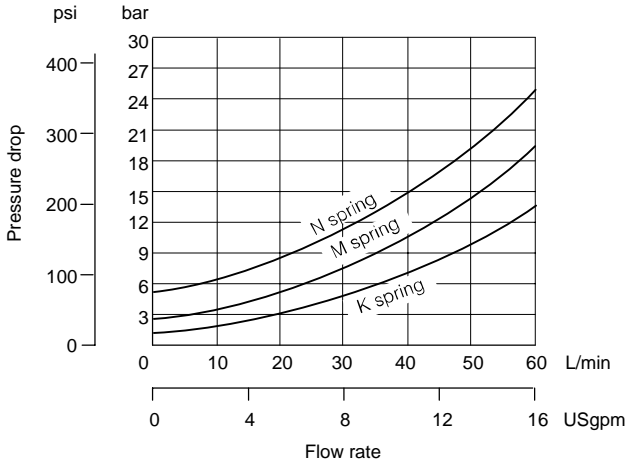

Pressure drop: flow path A to A1, or B to B1 with check valve pilot-operated fully open

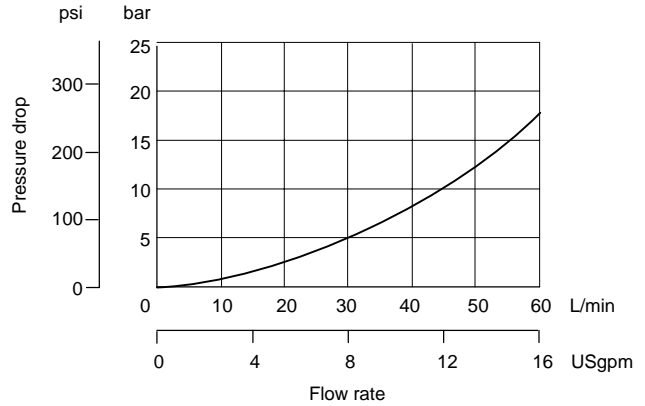

u For other viscosities see "Further Information".

Pilot Pressures

Pilot area ratios:

Main check valve 3:1

Decompression poppet 10:1

Use applicable ratio and opening/cracking pressure to calculate pilot pressure to open valve element, applied to the following formulae:

To open valve or decompression poppet in line A:

$$\text{Pressure at B1} = \frac{p_A + p_C - p_{A1}}{\text{Area ratio factor}} + p_{A1}$$

To open valve or decompression poppet in line B:

$$\text{Pressure at A1} = \frac{p_B + p_C - p_{B1}}{\text{Area ratio factor}} + p_{B1}$$

Where:

p_A = Pressure at A

p_C = Cracking/opening pressure

p_{A1} = Pressure at A1

p_B = Pressure at B

p_{B1} = Pressure at B1

A = }
 B = } Service line location;
 A1= } see functional symbols
 B1= }

Leakage

Less than 0,25 ml/min (0.015 in³/min) at 250 bar (3625 psi).

Installation Dimensions in mm (inches)

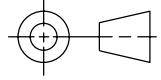

DGMPC-3-(D)AB*-(D)BA*-4*

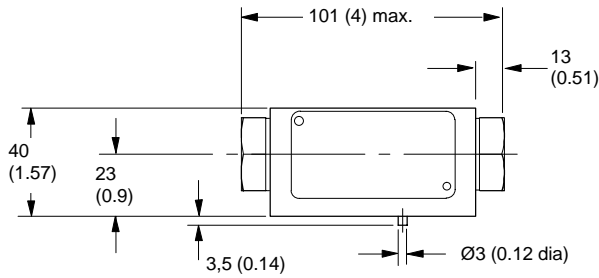
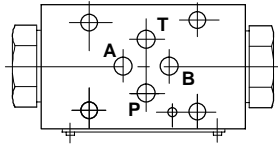

DGMPC-3-(D)AB*-4*

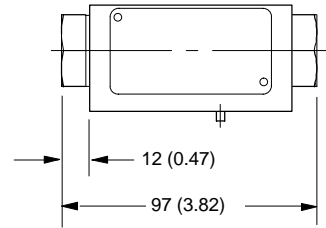
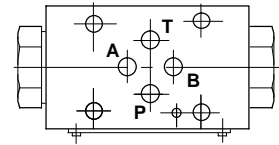

4 holes through: Ø5,3 (0.21 dia)

4 off "O" seals supplied for this mounting face

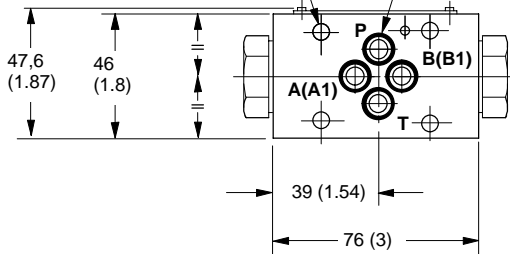

DGMPC-3-(D)BA*-4*

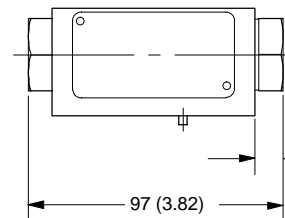

Flow Restrictor Valves DGMFN-3-4*

General Description

These valves regulate flow by means of an adjustable orifice which is not pressure compensated, and flow through the valve is entirely dependent upon pressure drop at any particular setting of the orifice.

Dual service-line models with an integral non-return valve around each control orifice provide for meter-in or meter-out control; single line versions of these are available.

For flow restriction in P or T lines (where reverse free flow is not required) models without check valves are available.

Adjustment options are either screw/locknut or handknob.

Typical Section

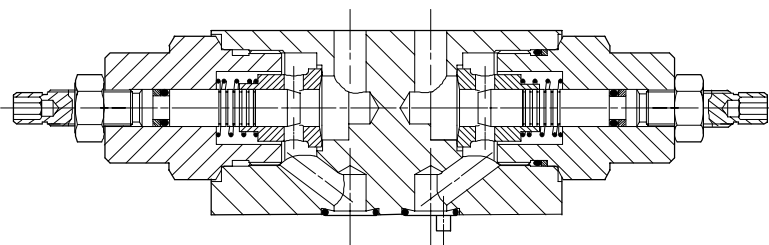

Model Code for Flow Restrictor Valves DGMFN-3- * - * * * (- * * *)-4*

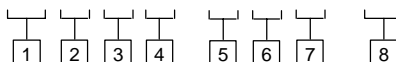

Functional Symbols

DGMFN-3-X-A**-B**

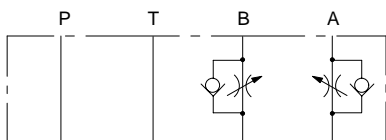

DGMFN-3-Y-A**-B**

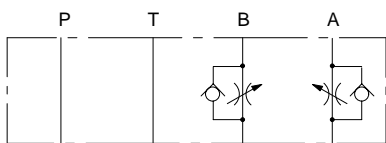

DGMFN-3-Z-P**



DGMFN-3-Z-T**

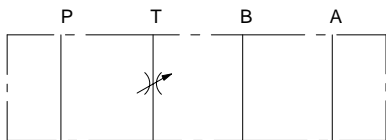

1 Direction of flow control (with respect to machine actuator)

X = Meter-in control, applicable to lines A and B

Y = Meter-out control, applicable to lines A and B

Z = Meter-in control, line P only and meter-out control, line T only.

2 Location of control function (single model or first line of dual model)

P = Line P (single model only)

T = Line T (single model only)

A = Line A (single model or first line of dual model)

B = Line B (single model only)

3 Type of control needle/orifice (single model or first line of dual model)

1 = Fine control

2 = Standard control

4 Adjuster type (single model or first line of dual model)

H = Handknob

W = Screw/locknut

5 Control in second line

B = Line B (use for dual models with "A" specified at 2)

Omit for single models

6 Type of control needle/orifice (second line of dual models)

Options as in 3

Omit for single models

7 Adjuster type (second line of dual models)

Options as in 4

Omit for single models

8 Design number, 40 series

Subject to change. Installation dimensions unaltered for design numbers 40 to 49 inclusive.

Performance Characteristics

Pressure Drop

Typical performance with mineral oil at 21 cSt (102 SUS) and at 50°C(122°F)●

Type "1" needle (see model codes 3 and 6)

Type "2" needle (see model codes 3 and 6)

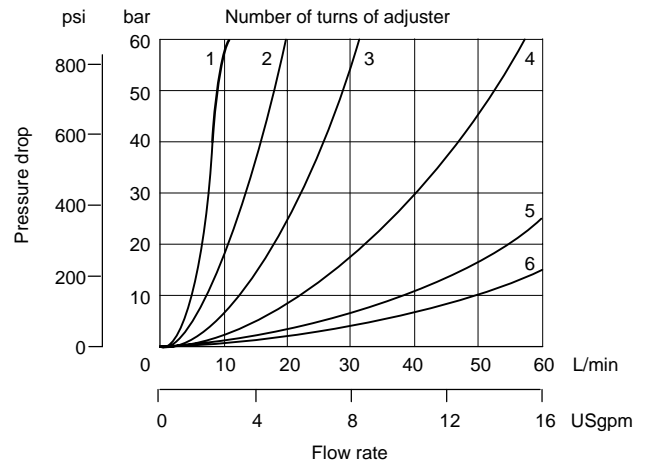
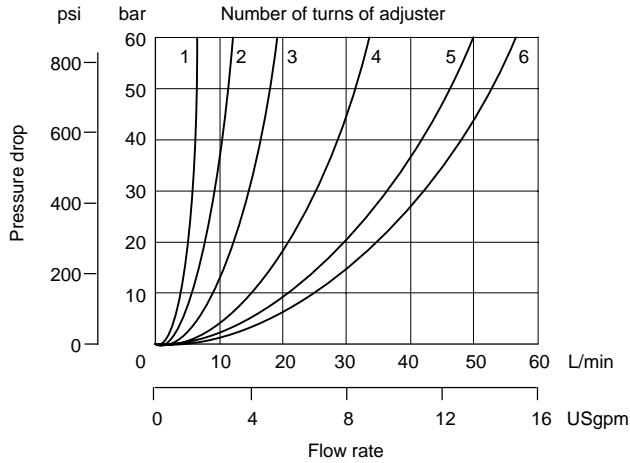

Free flow through check valve

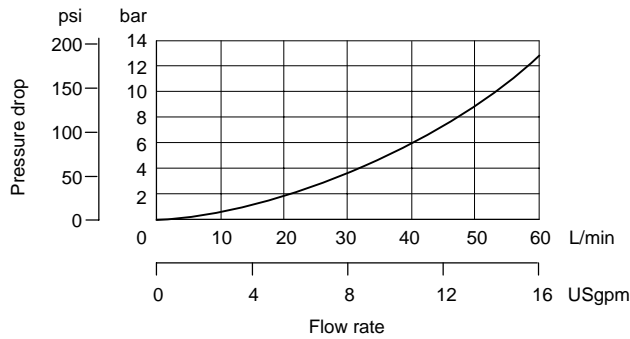

● For other viscosities see "Further Information".

Installation Dimensions in mm (inches)

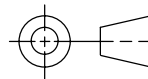

DGMFN-3-X-*(-***)-4***
DGMFN-3-Y-*(-***)-4***
DGMFN-3-Z-*-4***

Models with type W adjuster

To adjust valve setting, slacken off locknut and turn screw. Re-tighten locknut after completing adjustment.

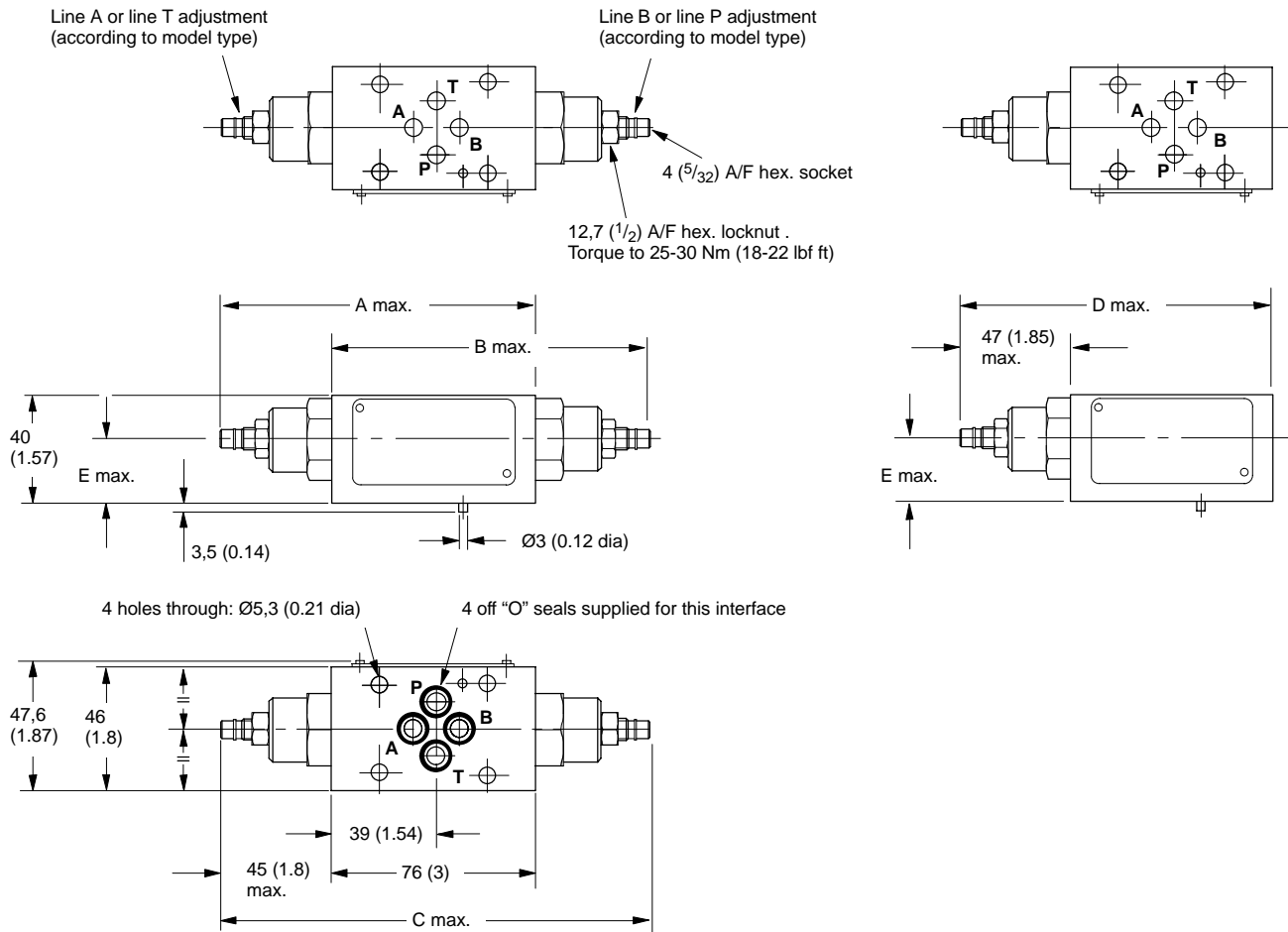

Type H adjuster

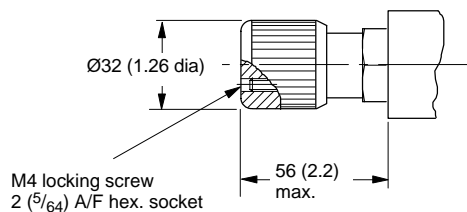

■ Turn clockwise to decrease flow (increase restriction); counter-clockwise to increase flow (reduce restriction).

Model	A	B	C	D	E
DGMFN-3-X-A*W-4*	121 (4.76)	–	–	–	16,75 (0.7)
DGMFN-3-X-A*W-B*W-4*	–	–	167 (6.6)	–	16,75 (0.7)
DGMFN-3-X-B*W-4*	–	122 (4.8)	–	–	16,75 (0.7)
DGMFN-3-Y-A*W-4*	121 (4.76)	–	–	–	23,25 (0.9)
DGMFN-3-Y-A*W-B*W-4*	–	–	167 (6.6)	–	23,25 (0.9)
DGMFN-3-Y-B*W-4*	–	122 (4.8)	–	–	23,25 (0.9)
DGMFN-3-Z-P*W-4*	–	–	–	123 (4.8)	16,75 (0.7)
DGMFN-3-Z-T*W-4*	–	–	–	123 (4.8)	23,25 (0.9)

Further Information

Mounting Bolts, Subplates and Manifold Blocks

Mounting Bolts

The length of mounting bolt used to install a SystemStak assembly is dependent on the number of valves being used, plus the length needed for mounting other valves in the assembly, such as:

- solenoid operated, or other type of directional valve
- tapping plate
- blanking or crossover plate.

Vickers offers a large selection of bolt kits (one bolt kit for these SystemStak valves comprises 4 bolts) in metric and inch sizes as listed. To determine your needs, use the following guide for bolt length calculation.

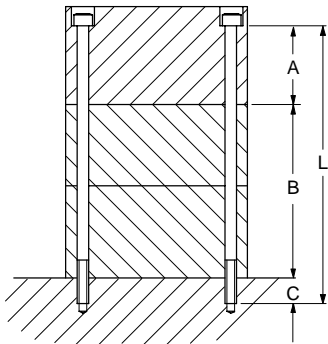

- A = Bolt clamp length in directional valve, blanking plate, crossover plate, etc.
- B = Height of intermediate valve stack, comprising Vickers SystemStak valve(s) plus tapping plates, etc.
- C = Depth of thread engagement in sub-plate/manifold block:
8/10 mm (0.3/0.4"), valid for:
315 bar (4500 psi) when using cast iron or steel subplates/manifold blocks, or 210 bar (3045 psi) when using Vickers aluminium alloy manifold blocks.
- L = Required bolt length; select from the table.

Notes

1. Bolts should be torqued to 7-9 Nm (63-80 lbf in) with threads lubricated.
2. If not using Vickers bolt kits, bolts must be to Grade 12.9 (ISO 898) or better.

Bolt Kit Selection

Metric: M5-6g		Inch: 10-24 UNC-3A	
Length (mm)	Vickers bolt kit number	Length (in)	Vickers bolt kit number
50	BKDG3699M	2.0	BKDG3698
60	BK466836M	2.375	BK466849
70	BK464125M	2.75	BK870017
80	BK466837M	3.125	BK466850
90	BK466838M	3.5	BK466851
100	BK466839M	3.937	BK466852
110	BK466840M	4.312	BK466853
120	BK466841M	4.75	BK466854
130	BK466842M	5.125	BK466855
140	BK466843M	5.5	BK466856
150	BK466844M	5.937	BK466857
160	BK466845M	6.312	BK466858
170	BK466846M	6.687	BK466859

Subplates and Manifold Blocks

See "Subplates and Auxiliary Connection Plates" catalog 2425.

Hydraulic Fluids

Materials and seals used in these valves are compatible with :

- Anti-wear petroleum oils L-HM
- Water glycols L-HFC
- Invert emulsions L-HFB
- Non-alkyl based phosphate esters L-HFD

The extreme operating range is 500 to 13 cSt (270 to 70 SUS) but the recommended running range is 54 to 13 cSt (245 to 70 SUS). For further technical information about fluids see 694.

Filtration Requirements

Recommendations on filtration methods and the selection of products to control fluid condition are included in Vickers publication 561 or 9132. For products in this catalog the recommended fluid cleanliness levels are:

- Up to 210 bar (3050 psi) 18/16/13
- Above 210 bar (3050 psi) 17/15/12

Temperature Limits

Ambient range –20°C to +80°C
(–4°F to +176°F)

Fluid temperatures

	Petroleum oil	Water-containing
Min.	–20°C (–4°F)	+10°C (+50°F)
Max.*	+80°C (+176°F)	+54°C (+129°F)

* To obtain optimum service life from both fluid and hydraulic system, 65°C (150°F) is the recommended maximum fluid temperature, except for water-containing fluids.

For other fluids where limits are outside those of petroleum oil, consult fluid manufacturer or Vickers representative. Whatever the actual temperature range, ensure that viscosities stay within those specified under "Hydraulic Fluids".

Further Information

Pressure Drop at Other Viscosities

Published pressure drop data is valid for a fluid viscosity of 21 cSt (102 SUS). The graph shows the approximate percentage change in pressure drop for a range of other viscosities. To determine the approximate pressure drop for any given fluid viscosity, multiply the published data by the % factor for the required viscosity.

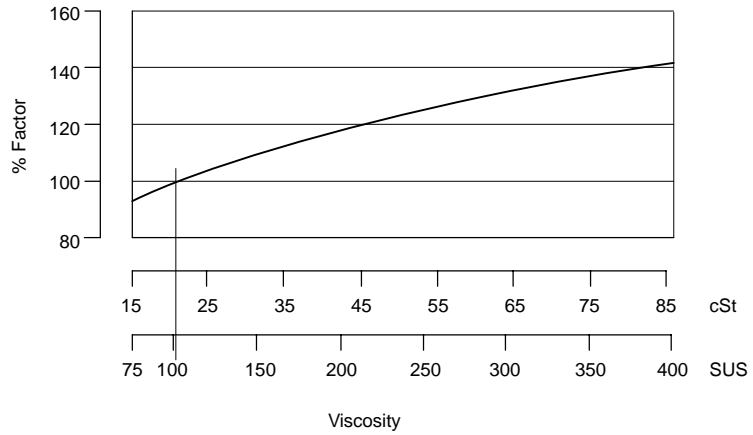

Type H Adjuster

To adjust valve setting, slacken M4 locking screw and rotate knob . Re-tighten locking screw after completing adjustment.

Available on
 DGMC-3
 DGMR-3
 DGMX-3

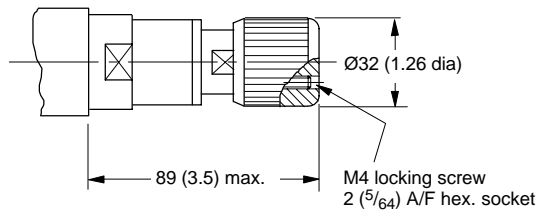

Type K Adjuster

Key must be inserted and turned to allow valve to be adjusted . When key is removed, adjustment mechanism can be freely turned without changing valve setting.

Available on
 DGMC-3
 DGMR-3
 DGMX-3

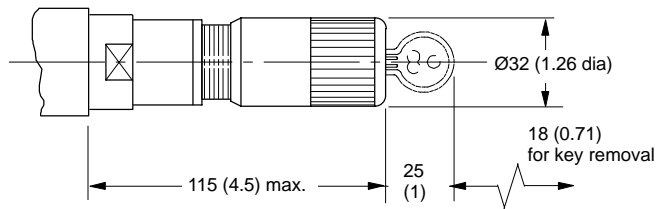

Turn clockwise to increase pressure;
 counter-clockwise to decrease pressure

Spare Parts

Valves are sold complete with all seals. Part numbers for available spare seal kits:

DGMC-3-40/41	870738
DGMC2-3-40/41	870737
DGMR(1)-3-40/41	870739
DGMX(*)-3-40/41	870739
DGMDC-3-40/41	870708
DGMPC-3-40/41	870708
DGMFN-3-40/41	870707

Note: Seal kits cover various model options for the respective types. Redundant seals will be found for some models.

Warranty and Repair

Units to be returned under warranty should be sent, with a description of the fault, to the Vickers representative in your area.

Repair of these size 03 valves is not generally economically viable. Contact your nearest Vickers representative before returning any unit for repair.

Ordering Procedure

Specify requirements by valve model code, and by seal kit number.

Vickers®
Solenoid Operated Directional Valves
Catalog

DG4V-3 flows
to 80 l/min
(21 USgpm),
6* design

DG4V-3S flows
to 40 l/min
(10.5 USgpm),
6* design

ISO 4401,
size 03; ANSI/
B93.7M-D03



EATON

Powering Business Worldwide

Table of Contents

Introduction.....	.01
Features and Benefits.....	.02
Characteristics.....	.03
Functional Symbols.....	.04
Model Code.....	.05
Operating Data.....	.07
Performance Data.....	.09
Installation Dimensions.....	.12
DG4V-3-*A(L)-(V)M-S6-U-**-60.....	.14
DG4V-3-*A(L)-(Z)-(V)M-S3-FPA5W-*2-60.....	.14
DG4V-3-*A(L)-(Z)-(V)M-S4-FPA5W-*2-60.....	.14
DG4V-3-*A(L)-(Z)-(V)M-S5-F-*2-60.....	.14
Electrical Plugs and Connectors.....	.15
Subplates, Connection Plates and Mounting Surfaces.....	.18
DGMA-3-B-1* Blanking Plate.....	.19
DGMA-3-C2-11 Crossover Plate.....	.19
DGMA-3-T*-1*-* Tapping Plate.....	.19
DGAM-3-01-1*-R (Metric bolt tapping) DGAM-3-01-1* (UNC bolt tapping).....	.20
Adaptor plate, Size 05 to 03 for pressure up to 210 bar (3000 psi).....	.20
DGVM-3-1*-*, DGMS-3-1E(Y)-1*-* Single station subplate, rear and side tapped port.....	.21
DGMS-3-3E-1*-* Multi-station subplate.....	.22
Mounting Surface.....	.23
Appendix.....	.24
Mounting Bolts.....	.24
Spare Parts Data.....	.25
Seal Kits.....	.25
Solenoid Coils.....	.25
Mass, approx. kg (lb).....	.25
Mounting Attitude.....	.25
Temperature Limits.....	.26
Fluid Temperature.....	.26
Fluid Cleanliness.....	.26
Ordering Procedure.....	.26

Introduction

General description

These solenoid operated directional control valves are for directing and stopping flow at any point in a hydraulic system. This 60-design series has been specially designed and developed to cover expanded demands in the industry as well as the many traditional uses of the earlier designs. Some of the more important benefits to users are outlined.

- Efficient control of greater hydraulic powers without increasing solenoid power consumption.
- Installed cost and space savings from higher power/weight-and-size ratios.
- Increases system efficiency; the result of improved manufacture of spools and bores.
- Installation flexibility resulting from choice of numerous combinations of solenoid connectors and locations.
- Multi-fluid capability without need to change seals.
- Higher sustained machine productivity and higher uptime because of proven fatigue life and endurance, tested over 20 million cycles.
- Solenoid coils can be changed quickly and easily without leakage from hydraulic system.
- Compact, cost effective system design when used with Vickers® SystemStak™ valves and subplates.

DG4V-3 and DG4V-3S High and standard performance models:

- Up to 80 l/min (21 USgpm) and up to 40 l/min (10.5 USgpm) respectively at 350 bar (5000 psi).
- Builds on Eaton's experience as the major supplier of size 03 valves worldwide.
- Offers designers the opportunity to select the optimum value package for each application.
- International standard interface. The valve mounting face conforms to ISO 4401, size 03 and is compatible with related international standards.

Features and Benefits

• High pressure and flow capabilities, thanks to special design features

Highly reliable operation up to 80 l/min (21 USgpm) at 350 bar (5000 psi). Establishes new market standards and opens new possibilities to design engineers on valve size selection.

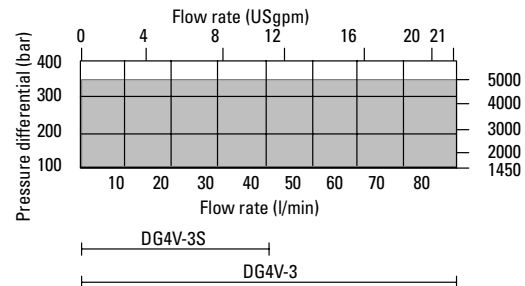
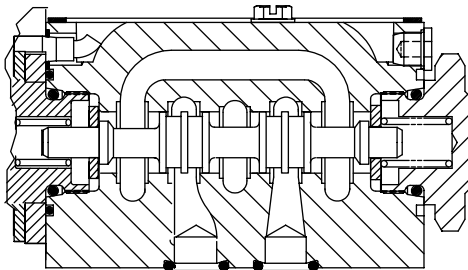

Typical maximum pressure differential (P-A-B-T) flow envelope, blocked center spool.

Features and Benefits

- **Minimal pressure drop, i.e. 2,5 bar (36 psi) at 30 l/min (7.9 USgpm)**

Achieved by optimization of the valve body, spool and spool-stroke design. The results: low energy consumption and improved efficiency.

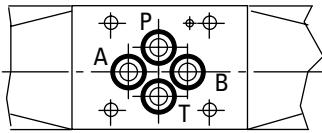
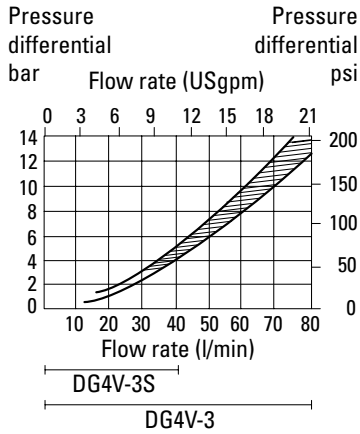

Mounting surface to ISO 4401 size 03

- **Ease of servicing**

Wet-armature solenoid, screw-in core tube design allows coils to be changed without removing valve from installation and without oil spillage or risk of contaminating system fluid.

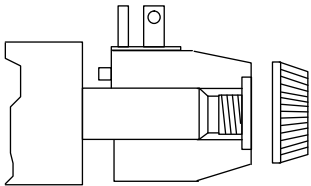

ISO4400 (DIN 43650) coil shown

- **High reliability**

Design of spring forces and profile of DC solenoid force characteristics ensure spool position selection under extreme operating conditions. Result is a valve with high reliability when being energized or de-energized.

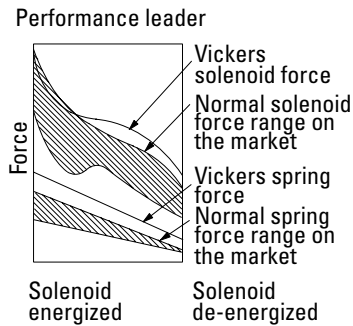

- **Electrical connections**

Conduit box design that simplifies electrical wiring connections to solenoids. Orientation tabs prevent incorrect positioning.

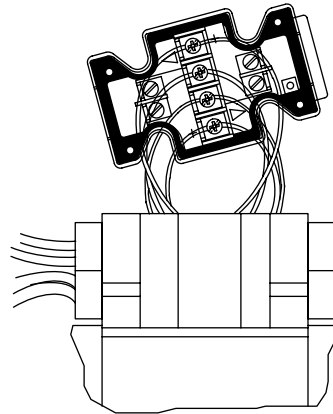

- **Scratch-proof manual override seal**

Internal seals are located such that they are beyond reach of any bore damage caused by small tools used to operate the manual override.

Result is no messy oil drips from the manual overrides.

Small diameter manual overrides prevent inadvertent operation.

- **DG4V-3 – High Performance**

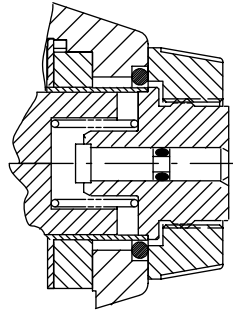

- **DG4V-3S – Standard Performance**

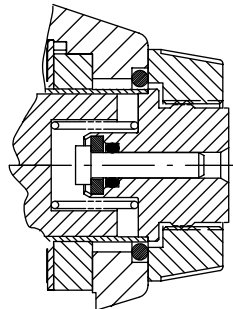

- **Surge suppression for DC valves**

Surge suppression is used to prevent coil damage by reducing contact burnoff – increasing switch life – and protecting electrical controllers from inductive spikes.

Three coil options are available:

- D1 – Encapsulated diode (Industrial application)
- D2 – Encapsulated diode (Mobile application)
- D7 – Transzorb type

Characteristics

High performance DG4V-3, 6* design

Standard performance DG4V-3S, 6* design

Mounting interface

ISO 4401 size 03
ANSI/B93.7M size D03
CETOP RP65H, size 3
DIN 24340, NG6

Basic characteristics

Maximum pressure:
DG4V-3 350 bar (5075 psi)
DG4V-3S 350 bar (5075 psi)

Maximum flow:
DG4V-3 up to 80 l/min
(21 USgpm)
DG4V-3S up to 40 l/min
(10.5 USgpm)

DG4V-3 models are direct solenoid operated four-way directional control valves. Their primary function in a hydraulic circuit is to direct fluid flow. This, in turn, would determine the direction of movement of a fluid cylinder, or the direction of rotation of a fluid motor.

Port connections are made by mounting the valve on a subplate or manifold. The valve has wet armature type solenoids.

Electrical connections to the valve are made in the electrical wiring housing or thru various plug-in connectors such as a DIN 43650 type coil.

Good hydraulic design practice suggests that detented models be mounted with longitudinal axis horizontal. Other models may be mounted in any position.

Operating considerations

1. Dependent on the application and the system filtration, any sliding spool valve if held shifted under pressure for long periods of time, may stick and not move readily due to fluid residue formation. It may therefore need to be cycled periodically to prevent this from happening.

2. Surges of fluid in a common tank line serving two or more valves can be of sufficient magnitude to cause inadvertent shifting of these valves. This is particularly critical in no-spring detented models, separate drain lines are necessary.

Temperature limits

Minimum ambient
-20°C (-4° F)

Maximum ambient
Valves with coils listed in model code and at stated percentages of rated voltage.

Construction of a typical single solenoid model

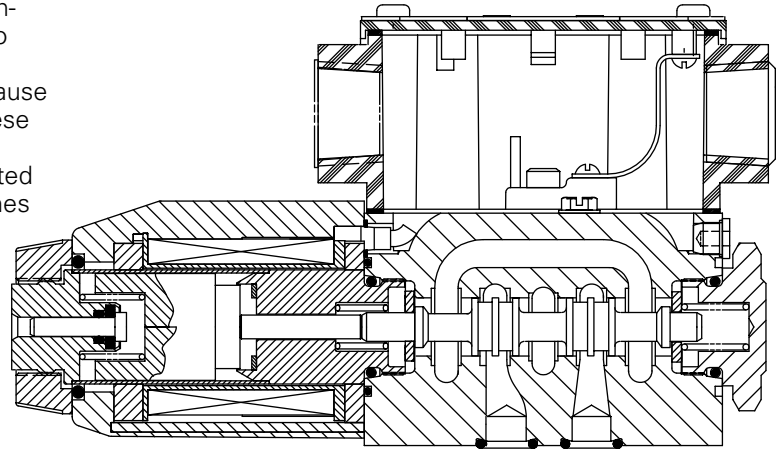

Fluid temperature

FLUID TEMP.	MINERAL OIL	WATERCONTAINING
Min	-20°C (-4°F)	+10°C (+50°F)
Max.*	+70°C (+158°F)	+54°C (+129°F)

* To obtain optimum service life from both fluid and hydraulic system, 65°C (150°F) normally is the maximum temperature except for watercontaining fluids.

COIL TYPE AND FREQUENCY	PERCENTAGE VOLTAGE	MAXIMUM AMBIENT TEMPERATURE	
		DG4V-3	DG4V-3S
Dual frequency coils			
@ 50 Hz	107%	40°C (104°F)	65°C (149°F)
@ 50 Hz	110%	30°C (86°F)	65°C (149°F)
@ 60 Hz	107%	50°C (122°F)	65°C (149°F)
@ 60 Hz	110%	40°C (104°F)	65°C (149°F)
Single frequency (50 Hz) coils			
@ 50 Hz	110%	40°C (104°F)	65°C (149°F)
DC coils	110%	70°C (158°F)	70°C (158°F)

For synthetic fluids consult manufacturer or Eaton representative where limits are outside those for mineral oil.

Whatever the actual temperature range, ensure that viscosities stay within the limits specified in the "Hydraulic fluids" section.

Functional Symbols

Spool types shown represent the highest proportion of market requirements. For other spool functions that may be required, consult your Eaton sales representative.

Solenoids identified to U.S. standards

Functional symbols related to solenoid identity "A" and/or "B" according to NFPA/ANSI standards, i.e. energizing solenoid "A" gives flow P to A, solenoid "B" gives flow P to B (as applicable).

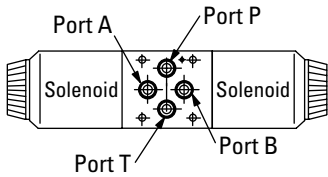

SOLENOID	FOR SPOOL TYPE	SOLENOID
B	All	A
	except "8"	
A	"8" only	B

For valves with type "8" spools, solenoid identity to U.S. convention is the same as for European convention.

Solenoids identified to European standards (specify "V" in model code)

Functional symbols related to solenoid identity "A" and/or "B" according to European convention i.e. solenoid "A" adjacent to "A" port, solenoid "B" adjacent to "B" port of valve.

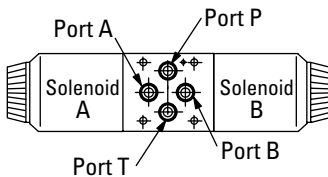

- For differences in valve function, refer to Performance Data page 11.
- ◇ F build spools.

U.S. solenoid standard

Double solenoid valves, two position, detented

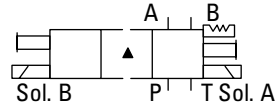

Double solenoid valves, spring centered

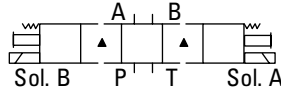

▲ Transient condition only

Single solenoid valves, solenoid at port A end

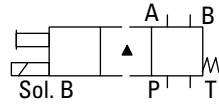

Single solenoid valves, solenoid at port B end

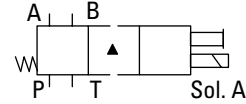

The valve function schematics apply to both U.S. and European valves.

DG4V-3(S)-*N(V)

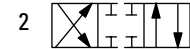

DG4V-3(S)-*A(V)

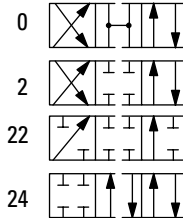

DG4V-3(S)-*AL(V)

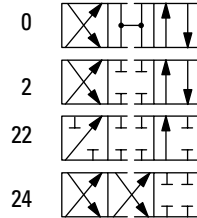

DG4V-3(S)-*C(V)

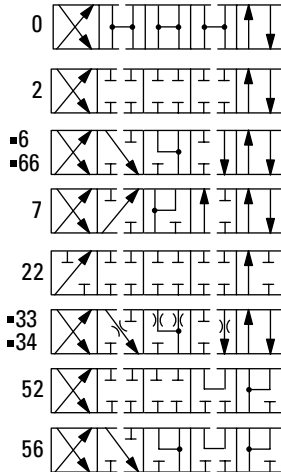

DG4V-3(S)-*B/F(V)

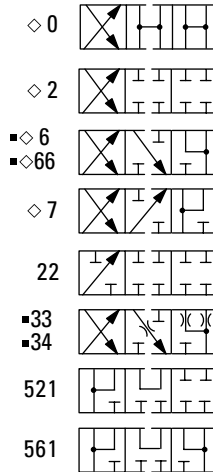

DG4V-3(S)-*BL/FL(V)

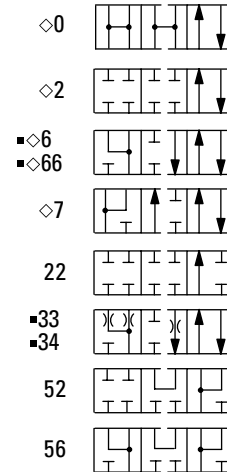

DG4V-3(S)-8C(V)

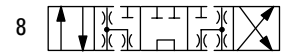

DG4V-3(S)-8BL(V)

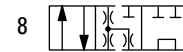

DG4V-3(S)-8B(V)

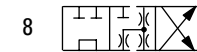

European solenoid standard

Double solenoid valves, two position, detented

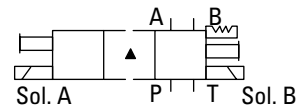

Single solenoid valves, solenoid at port A end

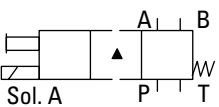

Single solenoid valves, solenoid at port B end

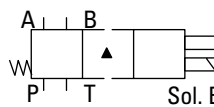

Double solenoid valves, spring centered

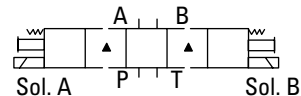

▲ Transient condition only

Model Code

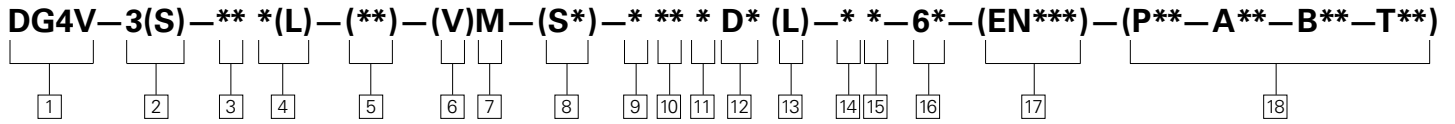

1 Model Series

- D** – Directional valve
- G** – Subplate/manifold mounted
- 4** – Solenoid operated
- V** – Pressure rating 350 bar (5075 psi) on P, A & B ports

2 Standard or high performance

- 3** – High performance specification: up to 80 l/min (21 USgpm) at 350 bar (5075 psi)
- 3S** – Standard performance specification: up to 40 l/min (10.5 USgpm) at 350 bar (5075 psi)

3 Spool type

See “Functional symbols” section.

4 Spool Spring Arrangement

- A** – Spring offset, end-to-end
- AL** – Same as “A” but left hand build
- B** – Spring offset, end to center
- BL** – Same as “B” but left hand build
- C** – Spring centered
- F** – Spring offset, shift to center
- FL** – Same as “F” but left hand build
- N** – No-spring detented

5 Manual override option

- No symbol** – Plain override(s) in solenoid end(s) only ▲
- H** – Water-resistant override(s) on solenoid end(s) ▲
- H2** – Water-resistant override both ends of solenoid.
- P2** – Plain override both ends of single solenoid.
- Y●** – Latching manual override on solenoid ends (includes “H” feature seal) ▲
- Z** – No overrides at either end
- ▲ No override in non-solenoid end of single solenoid valves
- Not available on DG4V-3S, AC models

6 Solenoid energization identity

- V** – Solenoid “A” is at port “A” end and/ or solenoid “B” is at port “B” end, independent of spool type

Omit for U.S. ANSI B93.9 standard requiring solenoid “A” energization to connect P to A and/or solenoid “B” to connect P to B, independent of solenoid location.

NOTE: Type “8” spool valves conform to both U.S. and European solenoid designations. When ordering an “8” spool, designate a “V” in the model code.

7 Flag symbol

- M** – Electrical options and features

8 Spool indicator switch

Available on high performance models, DG4V-3, only. Omit when not required.

DG4V-3-*(A(L)-(V)M models with type U (ISO4400) electrical connector to solenoid; spool type 0, 2 or 22 only:

- S6** – LVDT type DC switch with Pg7 connector plug.

DG4V-3-*(A(L)-(Z)-(V)M-S*-FPA5W valves with mechanical type AC (~) switch, wired to 5-pin receptacle:

- S3** – Switch, wired normally open
- S4** – Switch, wired normally closed

DG4V-3-*(A(L)-(Z)-(V)M-S5-F(T) W/J valves with mechanical type AC (~) switch:

- S5** – Switch, free leads

9 Coil type

- U** – ISO 4400 (DIN 43650) mounting ◆
- U1** – Connector fitted
- U6** – Connector fitted w/lights
- U11** – Connector fitted w/rectifier & lights**
- U12** – Connector fitted w/rectifier**
- F** – 1/2" NPT thread conduit box
- KU** – Top exit flying leads*
- SP1** – Single 6,3 mm spade* ◆
- SP2** – Dual 6,3 mm spade* ◆
- X1** – Flame resistant solenoids TP EEx-d-11B-T4
- X2** – Hazardous location solenoids to meet UL & CSA approval
- X3** – Special protection solenoids to BASEEFA standar SFA009:1972, protection class EX-S-11-T4

- ◆ Female connector to be supplied by customer

- * DC service only
- ** AC service only

10 Electrical connector

- T** – Wired terminal block
- PA** – Instaplug male receptacle only
- PB** – Instaplug male & female receptacle
- PA3** – Three pin connector
- PA5** – Five pin connector

11 Housing (F type coils only)

- W** – 1/2" NPT thread wiring housing
- J** – 20 mm thread wiring housing

12 Surge suppressor/damper

- D1** – Encapsulated diode (Industrial applications)
- D2** – Encapsulated diode (Mobile applications)
- D7** – Transzorb type (F,KU,U,SP1,SP2 only)

13 Solenoid indicator lights

Not available on PA, KU, U, SP1 & SP2

14 Coil rating

Full power coils, see “Operating Data”.

- A** – 110V AC 50Hz
- B** ◆ – 110V AC 50Hz/120V AC 60 Hz
- C** – 220V AC 50 Hz
- D** ◆ – 220V AC 50 Hz/240V AC 60 Hz
- G** – 12V DC
- H** – 24V DC

For DG4V-3 only (not usable with DG4V-3S):

Low power coils, see “Operating Data” (Not available with “N” – No-spring detented models)

- BL** – 110V 50 Hz/120V 60 Hz
- DL** – 220V AC 50 Hz/240V AC 60 Hz
- GL** – 12V DC
- HL** – 24V DC

◆ For 60 Hz or dual frequency

Contact your Eaton representative for additional coil voltage options.

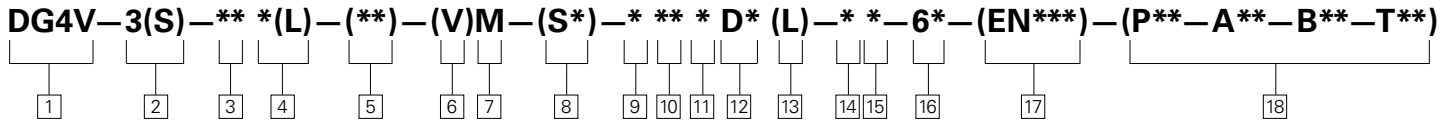

15 Port T code

Refer to “Operating Data” for port T pressure ratings.

- 2** – 10 bar (150 psi) for spool position indicator models S3, S4 and S5.
- 4** – 70 bar (1000 psi)
- 5** – 100 bar (1500 psi) for standard performance models, DG4V-3S, with AC or DC solenoids.
- 6** – 207 bar (3000 psi) for AC high performance models, DG4V-3, including spool position indicator type S6.
- 7** – 207 bar (3000 psi) for DC high performance models, DG4V-3, including spool position indicator type S6.

17 Special features

“EN***” code number assigned as required.

- EN21** – CSA approved models with 1/2” NPT entry conduit box, type FW and solenoid coil letter B,D,G, or H.

18 Port restrictor plugs

For details of plug orifice sizes and how to specify in model code see page 15. May be fitted to valves by agreement with your Eaton representative.

- Omit** – No restrictor plugs fitted

16 Design number

- 60** – Basic design
- 61** – Type 8 spool

Operating Data

Performance data is typical with fluid at 36cSt (168 SUS) and 50°C (122°F).

FEATURE	STANDARD PERFORMANCE VALVE DG4V-3S		HIGH PERFORMANCE VALVE DG4V-3	
Pressure Limits				
P, A and B ports	350 bar (5075 psi) ■		350 bar (5075 psi)	
T port:				
Spool indicator switch models				
Types S3, S4, S5	N/A		10 bar (145 psi)	
Type S6	N/A		210 bar (3045 psi)	
All other models	100 bar (1450 psi)		210 bar (3045 psi)	
Flow rating	See performance data		See performance data	
Relative duty factor	Continuous; ED = 100%		Continuous; ED = 100%	
Type of protection:				
ISO 4400 coils with plug fitted correctly	IEC 144 class IP65		IEC 144 class IP65	
SP1 – Single spade 6,3 mm	IEC 760		IEC 760	
SP2 – Dual spade 6,3 mm	IEC 760		IEC 760	
Coil winding	Class H		Class H	
Lead wires (coils type F***)	Class H		Class H	
Coil encapsulation	Class F		Class F	
Permissible voltage fluctuation:				
Maximum	Refer to temperature limits.		Refer to temperature limits.	
Minimum	90% rated		90% rated	
Typical response times at 100% rated volts measured from application/removal of voltage to full spool displacement of “2C” spool at:				
Flow rate P-A, B-T	20 l/min (5.3 USgpm)		40 l/min (10.6 USgpm)	
Pressure	175 bar (2537 psi)		175 bar (2537 psi)	
AC (~) energizing	18 ms		15 ms	
AC (~) de-energizing	32 ms		23 ms	
DC (=) energizing	60 ms		45 ms	
DC (=) de-energizing	40 ms		28 ms	
Power consumption, AC solenoids (for coils listed in model code).				
	Initial ▲ VA (RMS)	Holding VA (RMS)	Initial ▲ VA (RMS)	Holding VA (RMS)
Full power coils:				
Single frequency coils AC 50 Hz	225	39	265	54
Dual frequency coils at 50 Hz	265	49	280	61
Dual frequency coils at 60 HZ	260	48	300	58
Low power coils, “BL” and “DL”: (Not available with “N” – No-spring detented models)				
Dual frequency coils at 50 Hz	Low power coils not usable with DG4V-3S valves.		170	37
Dual frequency coils at 60 Hz			190	37
Power consumption, DC solenoids at rated voltage and 20 C (68 F).				
Full power coils:				
12V, model type “G”	30W	–	30W	–
24V, model type “H”	30W	–	30W	–
Low power coils:				
12V, model type “GL”	Low power coils not usable with DG4V-3S valves.		18W	–
24V, model type “HL”			18W	–

■ For applications where valves are to remain pressurized (either energized or de-energized) at pressures over 210 bar (3045 psi) without frequent switching, it is recommended to use the high performance model, DG4V-3.

▲ 1st half cycle; armature fully retracted.

Operating Data

Spool Position Indicator Models, high performance valve DG4V-3 ONLY

Spool/spring arrangement types 0A (L), 2A(L), 22A(L)

DC model type "S6"
(see page 14 for Installation Dimension)

CE This product has been designed and tested to meet specific standards outlined in the European Electromagnetic Compatibility.

Directive (EMC) 89/336/EEC, amended by 91/263/EEC, 92/31/EEC and 93/68/EEC, article 5. For instructions on installation requirements to

achieve effective protection levels see this leaflet and the Installation Wiring Practices for Eaton's Vickers® Electronic Products leaflet 2468. Wiring practices relevant to this Directive are indicated by  Electromagnetic Compatibility (EMC).

Input:	
Supply voltage	10 to 35V DC inclusive of a maximum 4V pk-to-pk ripple
Current, switch open	5 mA
Current, switch closed	255 mA
Output:	
Voltage	1V below input at maximum load
Maximum continuous current	250 mA
Maximum load impedance	136Ω at maximum input volts
Maximum switching frequency	10 Hz
Plug connections:	
Pin 1 (output 1)	Normally open (ie. not connected to pin 3)
Pin 2	Supply +ve
Pin 3	0V
Pin 4 (output 2)	Normally closed (ie. connected to pin 3)
Switching point	Within the spool spring offset condition •
Connector	Pg7 plug (supplied with valve)
Protection	Overload and short-circuit protected; self re-setting. IEC 144 class IP65 with connector correctly fitted.

• Factory setting ensures this condition under all combinations of manufacturing tolerance and of temperature drift (see "Temperature Limits").

Wiring Connections

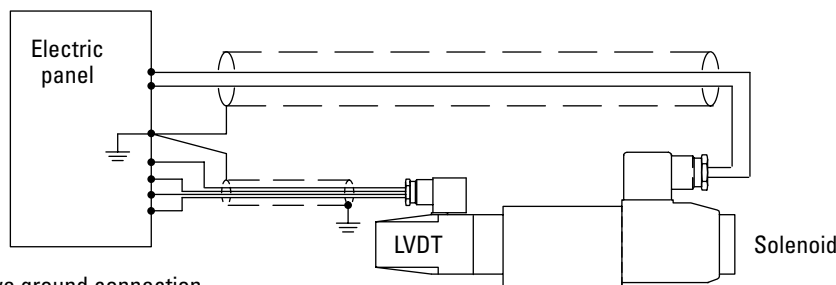

Warning

All power must be switched off before connecting or disconnecting any plugs

 Customer's protective ground connection



WARNING: Electromagnetic Compatibility (EMC)

It is necessary to ensure that the unit is wired up in accordance with the connection arrangements shown above. For effective protection the user's electrical cabinet, the valve subplate or manifold and the cable screens should be connected to efficient ground points.

In all cases both valve and cable should be kept as far away as possible from any sources of electromagnetic radiation such as cables carrying heavy current, relays and certain kinds of portable radio transmitters, etc. Difficult environments could mean that extra screening may be necessary to avoid the interference.

Micro-switch type "S3", "S4" and "S5"

Voltage	250V maximum 50/60 Hz
Maximum current	5A

Performance Data

Typical with mineral oil at 36 cSt (168.6 SUS) and a specific gravity of 0.87.

Maximum flow rates

Performance based on full power solenoid coils warm and operating at 90% rated voltage.

See note at bottom of next page when using low power coils (DG4V-3 models only).

DG4V-3S models (standard performance)

Graph 1

AC solenoid valves with dual frequency coils operating at 50 Hz

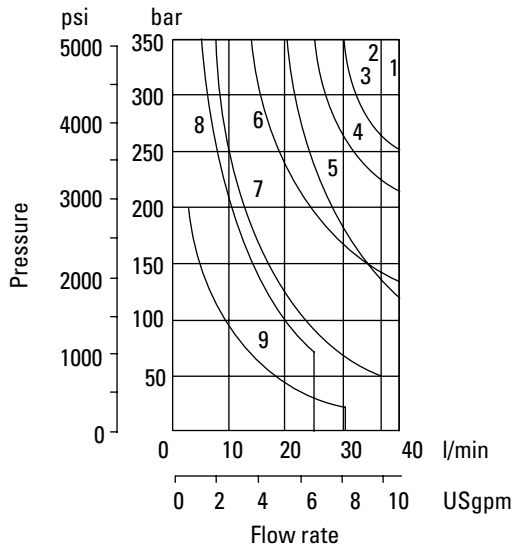

Graph 2

AC solenoid valves with
– Dual frequency coils operating at 60 Hz

– Single frequency (50 Hz) coils operating at 50 Hz

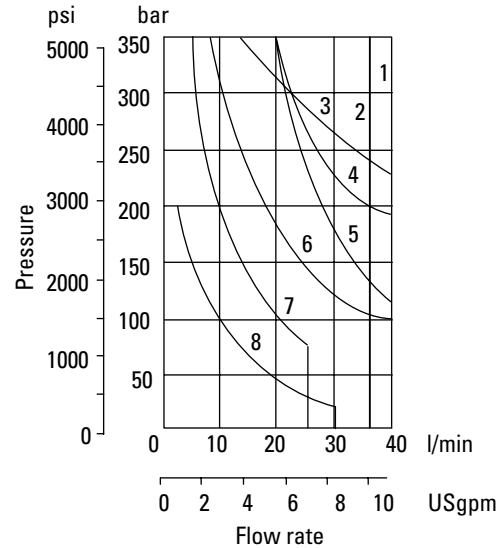

Graph 3

DC solenoid valves

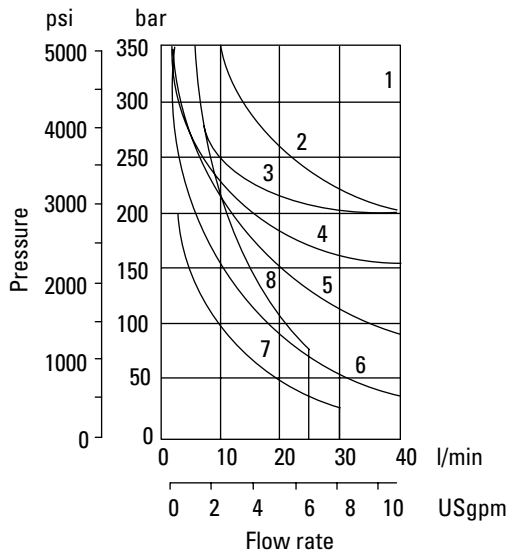

Spool/spring code	Graph 1 curve	Graph 2 curve	Graph 3 curve
0A(L)	1	1	3
0B(L) & 0C, 0F	1	1	1
2A(L)	5	5	3
2B(L) & 2C, 2F	2	2	3
2N	1	1	1
6B(L) & 6C, 6F	6	6	5
7B(L) & 7C, 7F	6	6	2
8B(L) & 8C	8 ▲	7 ▲	8 ▲
22A(L)	9	8	7
22B(L) & 22C	7	7	6
24A(L)	6	6	5
33B(L) & 33C	4	4	4
34B(L) & 34C	6	6	5
52BL, 52C,	6	6	5
56BL & 56C	6	6	5
66B(L) & 66C	3	3	5
521B & 561B	6	6	5

▲ Consult Eaton regarding each application that will jointly have flow rates approaching this curve and a pressurized volume exceeding 2000 cm³ (122 cu.in.)

Performance Data

DG4V-3 models (high performance)

Graph 4 – Single-frequency coils
AC solenoid valves with:
– Dual-frequency coils operating at 50 Hz

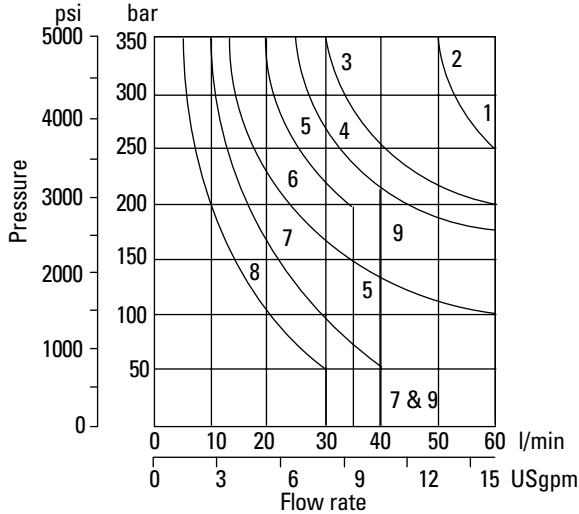

Graph 5 AC solenoid valves with dual-frequency coils operating at 60 Hz

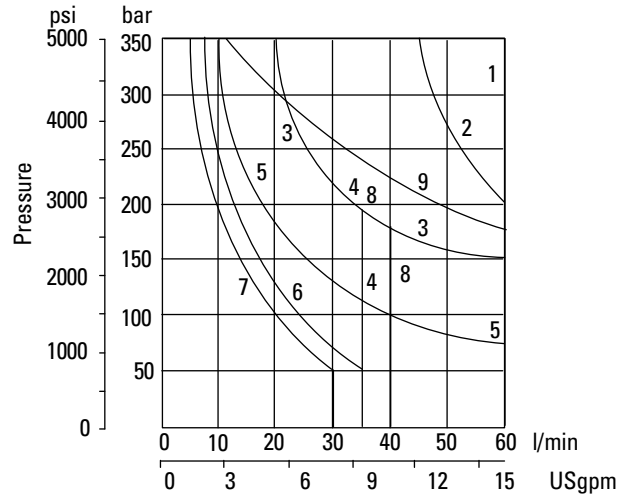

Graph 6 DC solenoid valves

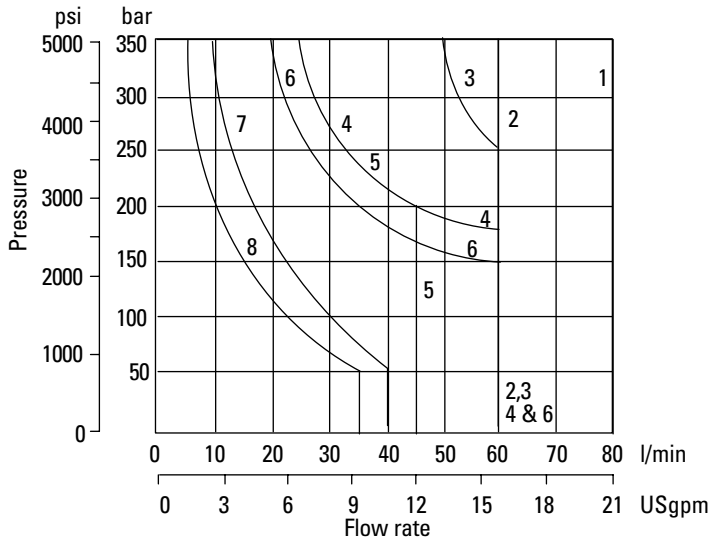

Spool/spring code	Graph 4 curve	Graph 5 curve	Graph 6 curve
0A(L)	2	2	3
0B(L) & 0C, 0F	1	1	2
2A(L)	2	2	3
2B(L) & 2C, 2F	1	1	1
2N	1	1	2
6B(L) & 6C, 6F	6	5	6
7B(L) & 7C, 7F	1	1	2
8B(L) & 8C	5 ▲	4 ▲	5 ▲
22A(L)	8	7	8
22B(L) & 22C	7	6	7
24A(L)	9	8	5
33B(L) & 33C	4	3	4
34B(L) & 34C	4	3	6
52BL, 52C,	6	5	6
56BL & 56C	6	5	6
66B(L) & 66C	3	9	6
521B & 561B	6	5	6

▲ Consult Eaton regarding each application that will jointly have flow rates approaching this curve and a pressurized volume exceeding 2000 cm³ (122 cu.in.)

Flow limits applicable to the following usages:

- All valves except types 22 and 52 spools having simultaneous equal flow rates from P to A or B and from B or A to T and S3, S4, S5 (limit switch) models.
- Valves with type 22 spools having flow from P to A or B, the other being plugged. T is drained at all times.
- Valves with type 52 spools having one service port (A or B as appropriate) connected to the full bore end of a 2:1 area ratio double-acting cylinder and the other to the annulus end.
- Consult Eaton, with application details, if either of the following usages are required:
 - Single flow path, i.e. P to A, P to B, A to T or B to T.

- Substantially different simultaneous flow rates between P to A or B and B or A to T, e.g. when A and B are connected to a cylinder having a large differential area.

Low Power Coils (DG4V-3 models only)

When using low power coils (coil designations *L in model code) the maximum flow is

reduced from values given on this page (graphs 4, 5 and 6) by up to:

- 70% – for DC coils
- 50% – for AC coils

depending on spool type. Consult your Eaton representative relative to specific applications for low power coils.

Performance Data

Pressure drops

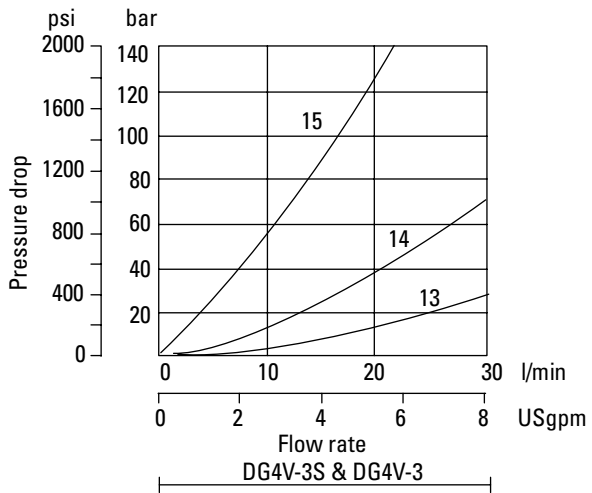
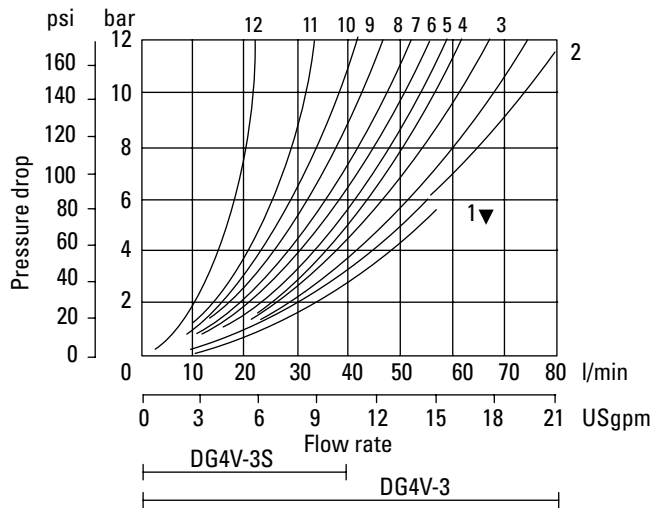

▼ Curve for spool type 6: not recommended for flows in excess of 60 l/min (15.8 USgpm).

Pressure drops in offset positions except where otherwise indicated

Spool/spring code	Spool positions covered	P to A	P to B	A to T	B to T	P to T	B to A or A to B
0A(L)	Both	5	5	2	2	—	—
0B(L) & 0C, 0F	De-energized	—	—	—	—	4▲▲	—
	Energized	4	4	2	2	—	—
2A(L)	Both	6	6	5	5	—	—
2B(L) & 2C, 2F	Energized	5	5	2	2	—	—
2N	Both	6	6	3	3	—	—
6B(L) & 6C, 6F	De-energized	—	—	3▲	3Δ	—	—
	Energized	6	6	1	1	—	—
7B(L) & 7C, 7F	De-energized	6▲	6Δ	—	—	—	7○
	Energized	4	4	3	3	—	—
8B(L) & 8C	All	9	9	5	5	3	—
22A(L), 22B(L) & 22C	All	6	6	—	—	—	—
24A(L)	De-energized	6	6	2	2	—	—
33B(L) & 33C	De-energized	—	—	15▲	15Δ	—	—
	Energized	5	5	2	2	—	—
34B(L) & 34C	De-energized	—	—	14▲	14Δ	—	—
	Energized	5	5	2	2	—	—
52BL & 52C	Energized	6▲	6Δ	2	—	—	10○
56BL	Both	6▲	6Δ	11▲	10Δ	—	10○
56C	De-energized	—	—	11▲	10Δ	—	10○
	Energized	6▲	6Δ	2	—	—	10○
66B(L) & 66C	De-energized	—	—	12	12	—	13
	Energized	6	6	2	2	—	—
521B	All	6▲	6Δ	—	—	—	10○
561B	De-energized	—	—	10▲	11Δ	—	10○
	Energized	6	6Δ	—	—	—	10○

▲ "B" plugged Δ "A" plugged ○ "P" plugged

For other viscosities, pressure drops approximate to:

Viscosity cSt (SUS)							
14	20	43	54	65	76	85	
(17.5)	(97.8)	(200)	(251)	(302)	(352)	(399)	
% of Δp							
81	88	104	111	116	120	124	

A change to another specific gravity will yield an approximately proportional change in pressure drop.

The specific gravity of a fluid may be obtained from its producer. Fire resistant fluids usually have higher specific gravities than oil.

Installation Dimensions

Models for use with ISO 4400 (DIN 43650) connectors



Double solenoid models ▲

Single solenoid models▲

DG4V-3(S)-*C-**-*(V)M-U-**-60

DG4V-3(S)-*A(-**) ■

DG4V-3(S)-*AL(-**) ■

DG4V-3(S)-*N-**-*(V)M-U-**-60

DG4V-3(S)-*B(-**) ■

DG4V-3(S)-*BL(-**) ■

DG4V-3(S)-8BL(-**) ■

DG4V-3(S)-8B(-**) ■

DG3V-3(S)-*F ■

DG4V-3(S)-*FL(-**) ■

As shown

Solenoid and end cap interchanged

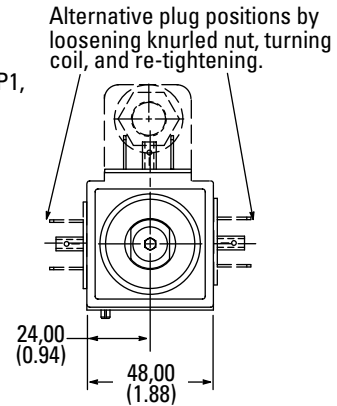
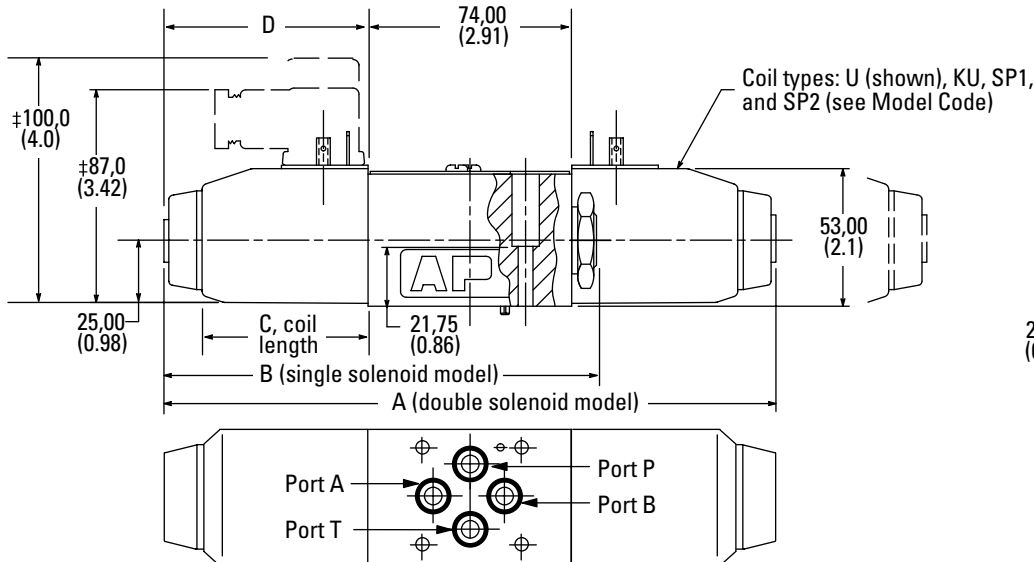

- Not applicable to type "8" spool.
- ▲ See page 25 for solenoid information.
- ‡ Can vary dependent on source of plug.

Model type	AC or DC	A Dim.	B Dim.	C Dim.	D Dim.
All	DC =	220 (8.66)	156 (6.14)	61 (2.5)	73 (2.87)
DG4V-3	AC ~	200 (7.87)	146 (5.75)	51 (2.1)	63 (2.48)
DG4V-3S	AC ~	200 (7.87)	146 (5.75)	45 (1.7)	63 (2.48)

Dimensions in mm(in).

Water-resistant manual override on solenoid

DG4V-3(S)-****(L)-H-(V)M-**-**-60

Application

General use where finger operation is required (standard manual overrides cannot be operated without using small tool).

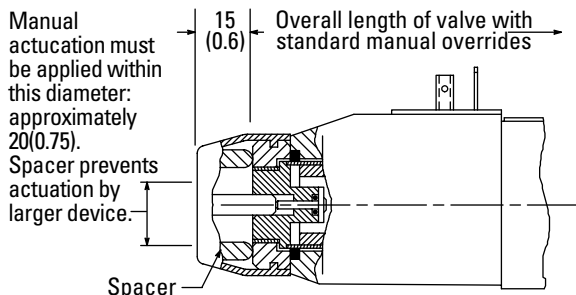

Note:
"H" feature is not field convertible from other models; specify with order.

Latching manual override on solenoid

DG4V-3-****(L)-Y-(V)M-**-**-60

DG4V-3S-****(L)-Y-(V)M-**-**-60, DC coil models only

Application

Stainless steel lever/latch mechanism and water-resistant seal make this feature ideal for vehicle-mounted and exposed applications requiring emergency selection of valve for a period of time in the event of electrical failure.

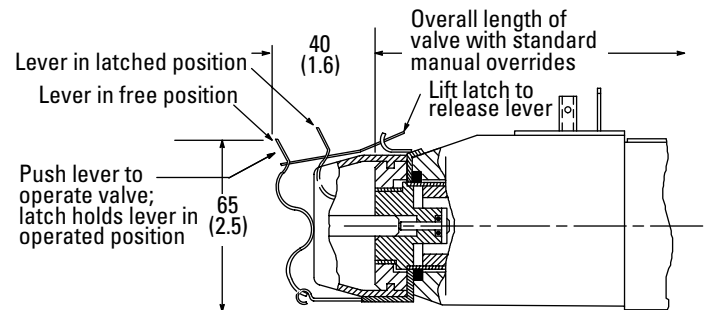

Notes:

1. Opposite solenoid (on "C" and "N" double solenoid models) should not be energized while the valve is latched in selected position; AC solenoid coils will burn out under this improper usage.
2. "Y" feature is field-convertible from "H" type manual override (omitting spacer), but is not field-convertible from other models.

Installation Dimensions

Models with "F" type coils (lead wires) and conduit box.

Double solenoid models ▲

DG4V-3(S)-*C-**-*(V)M-F-**-60
 DG4V-3(S)-*N-**-*(V)M-F-**-60

Single solenoid models ▲

DG4V-3(S)-*A(-**)●
 DG4V-3(S)-*B(-**)●
 DG4V-3(S)-8BL(-**)●
 DG3V-3(S)-*F●

As shown

DG4V-3(S)-*AL(-**)●
 DG4V-3(S)-*BL(-**)●
 DG4V-3(S)-8B(-**)●
 DG4V-3(S)-*FL(-**)●

Spolenoid and end cap interchanged

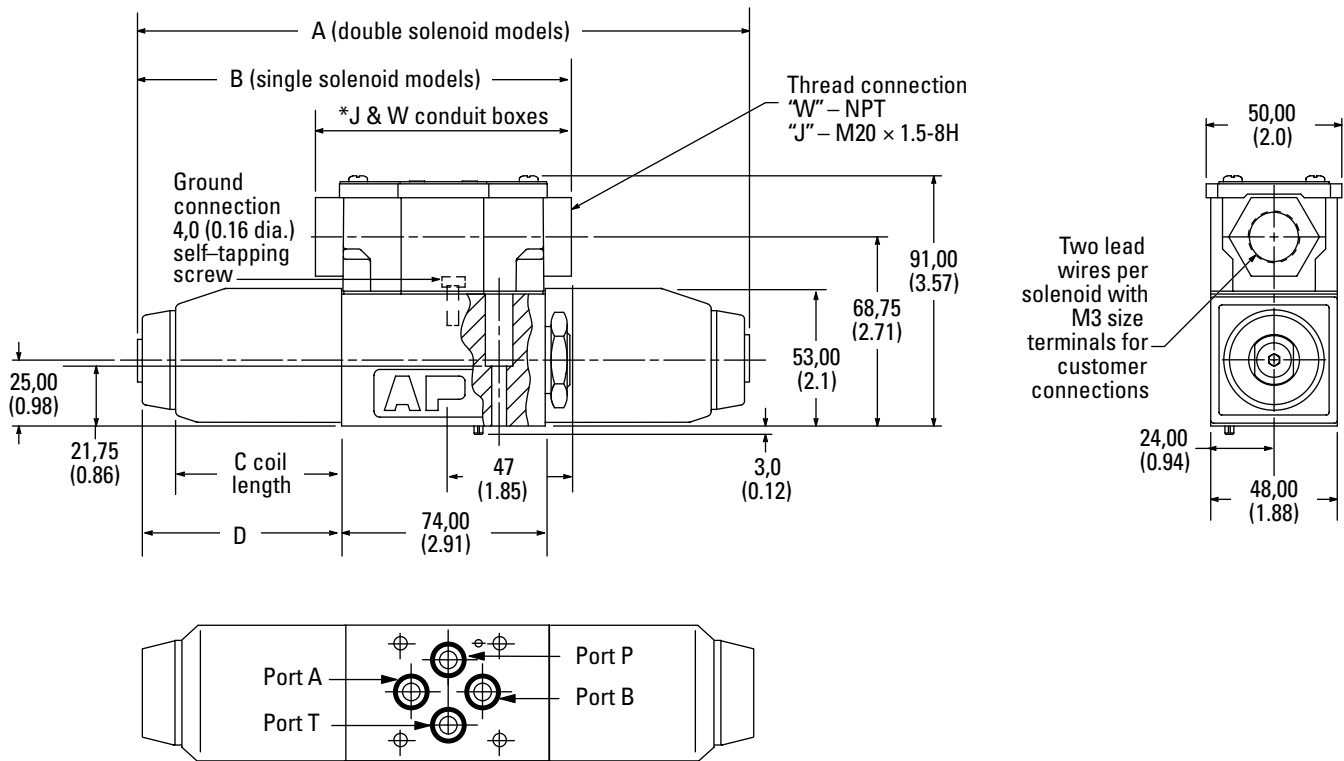

* 89 (3.5) for FPB – J & W conduit boxes
 104 (4.0) All plug-in conduit boxes

Dimensions in mm(in).

Model type	AC or DC	A Dim.	B Dim.	C Dim.	D Dim.
All	DC =	220 (8.66)	156,5 (6.14)	61 (2.5)	73 (2.87)
DG4V-3	AC ~	200 (7.87)	146,5 (5.75)	51 (2.1)	63 (2.48)
DG4V-3S	AC ~	200 (7.87)	146,5 (5.75)	45 (1.7)	63 (2.48)

● Not applicable to type "8" spool. ▲ See page 24 for solenoid information.

Codes "FJ" and "FW": 2 lead wires for each solenoid, approximately 150,00 (6.00) long. M3 (#6) terminals provided for customer connection.

Codes "FTJ" and "FTW": Valve supplied with lead wires connected into terminal strip suitable for M3 (#6) terminals for customer connection.

Installation Dimensions

DG4V-3-*A(L)-(V)M-S6-U-**-60

Single solenoid models with LVDT type switch indicating when the spool is in the spring off-set position. ISO 4400 (DIN 43650) connection to solenoid; Pg7 connection to switch.

▲For LH build (DG4V-3-*AL) solenoid and switch locations are reversed.

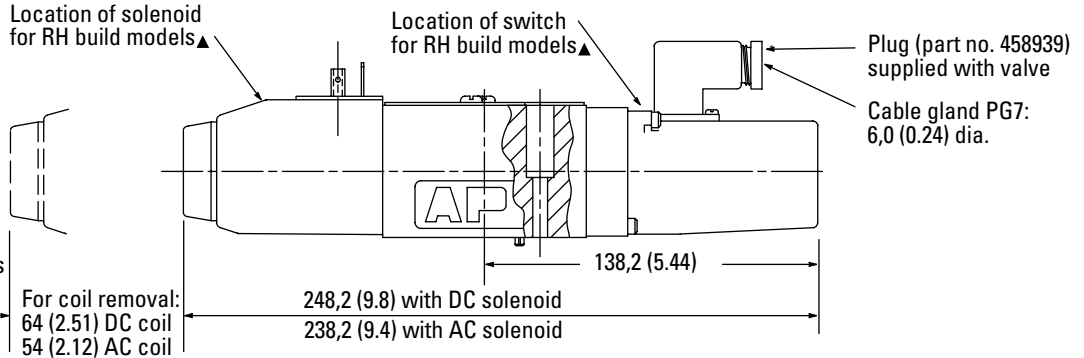

Warning

Wiring: See *Electromagnetic Compatibility (EMC)* warning note on page 8.

Dimensions in mm(in)

DG4V-3-*A(L)-(Z)-(V)M-S3-FPA5W-*2-60

DG4V-3-*A(L)-(Z)-(V)M-S4-FPA5W-*2-60

DG4V-3-*A(L)-(Z)-(V)M-S5-F-*2-60

Single solenoid models with mechanical type switch monitoring of spool movement.

Conduit box with leads, or pre-wired to NFPA T3.5.29-1980 receptacle.

Normally closed lead (Monitor switch) sleeving identification color white.

Common lead (Monitor switch) sleeving identification color black.

Normally open lead (Monitor switch) no color identification.

▲For LH build (DG4V-3-*AL) solenoid and switch locations are reversed.

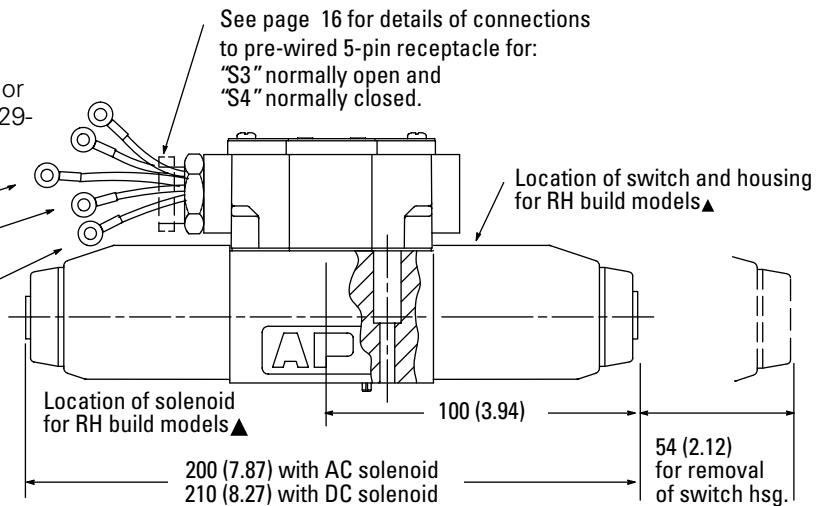

Port restrictor plugs

Restrictor plugs are available for use in ports P, T, A or B. These can be used for restricting flow or for circuit dampening. Restrictor plugs are not recommended for use above 210 bar (3000 psi) system pressure.

Typical model codes:

DG4V-3(S)-**-M-**-**-60-P08
(0.8 mm dia orifice in port P)

DG4V-3(S)-**-M-**-**-60-P10-A10
(1.0 mm dia orifice in ports P and A)

RESTRICTOR PLUG SELECTION TABLE

Code	Orifice diameter	Part number
*00	Blank	694353
*03	0,30 (0.012)	694341
*06	0,60 (0.024)	694342
*08	0,80 (0.030)	694343
*10	1,00 (0.040)	694344
*13	1,30 (0.050)	694345
*15	1,50 (0.060)	694346
*20	2,00 (0.080)	694347
*23	2,30 (0.090)	694348

* = P, T, A or B, as required

■ hhOrder in multiples of 25 per part number

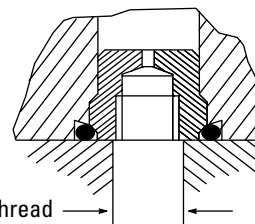

M5 x 0.8-6H thread for plug extraction

Maximum port dia in subplate/manifold block:

For steel and SG (ductile) iron: 7,0 (0.3)

For gray iron: 6,5 (0.25)

Electrical Plugs and Connectors

Terminal strip and lights

For valves with type "F" coils.

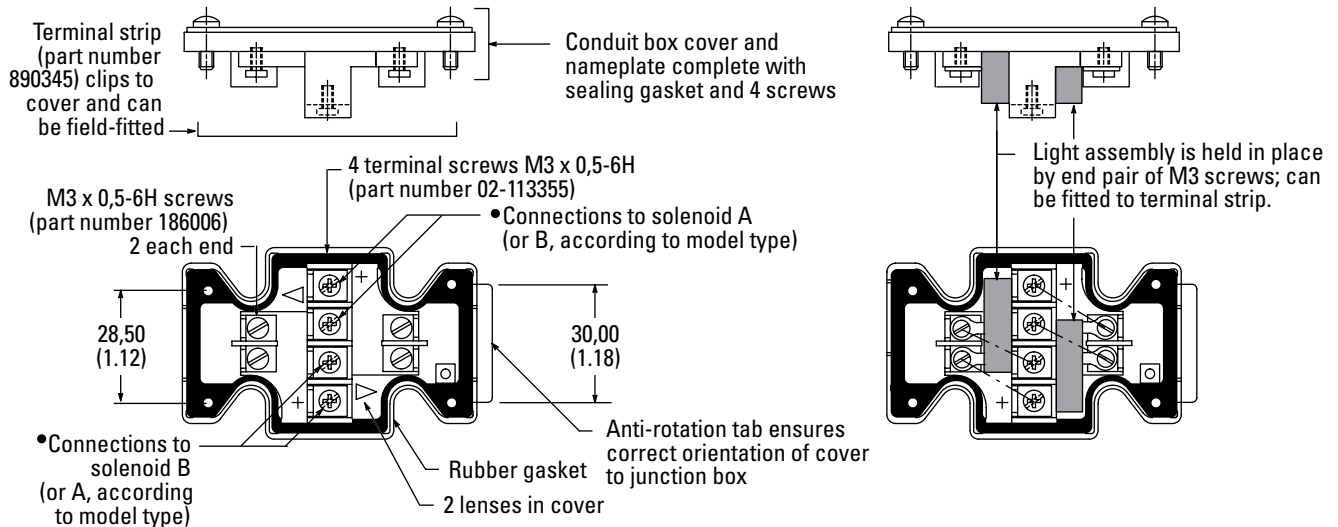

1. For DC coils the +ve lead(s) must be connected to the terminal(s) marked +. When using 3-wire incom-

ing leads to double solenoid valves (i.e. common neutral) the inner pair of terminals must be interconnected.

2. For correct light indication of energized solenoid ensure that solenoid leads are correctly connected: light

terminals are common with each outer pair of solenoid terminals according to the side with + mark.

Insta-Plug

DG4V-3(S)—FPA—60
DG4V-3(S)—FPBW—60
Eaton 2-part "Insta-Plug" eliminates breaking electrical inputs for valve disconnect. A male half is pre-wired to the valve body. The mating

plug is inside a wire housing with external terminals for machine wire connections. Captive thumb screws, when loosened, permit the wire housing to be pulled clear of the valve for disconnect. A

longer ground post provides first make/last break ground connection. The PBW configuration combines both male and female plugs in the wiring housing for a self-contained plug-in unit.

Optional solenoid indicator lights are pre-wired to the female plug. Solenoids "A" and/or "B" are identified on the wiring housing.

PA configuration

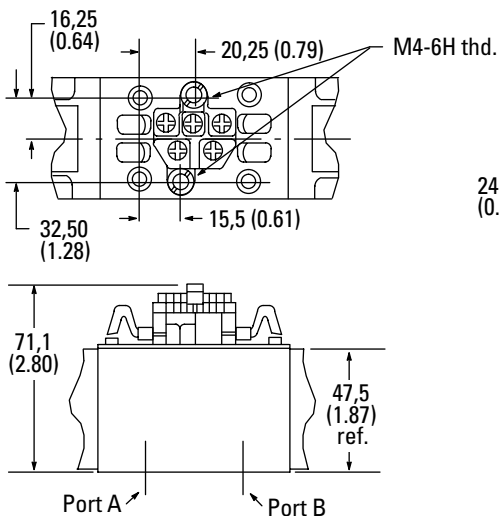

PBW configuration

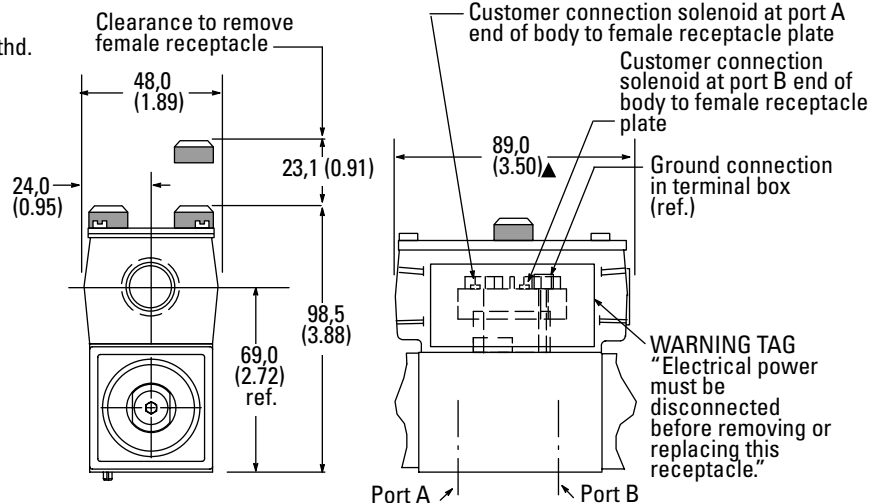

▲ The conduit box dimensions used for the PA/PBW type connector are different from those on the other "F" type coil models.

Dimensions in mm(in).

Electrical Plugs and Connectors

NFPA Connector T3.5.29-1980

DG4V-3(S)-FPA3W(L)-**-60
 DG4V-3(S)-FPA5W(L)-**-60
 DG4V-3-S3-FPA5W(L)-**-60
 DG4V-3-S4-FPA5W(L)-**-60

The receptacle is a standard three or five pole connector with shortened leads and terminals added. The five pole plug has four leads 101,6 (4.0) long and one 177,8 (7.0)

long. The three pole plug has two leads 101,6 (4.0) long and one 177,8 (7.0). All wires have underwriters recognized non-solder insulated eyelet terminals. The green wire is used for the ground (earth) connection (No. 8 screw furnished). Valves are supplied pre-wired.

Connection details and model type/model code references

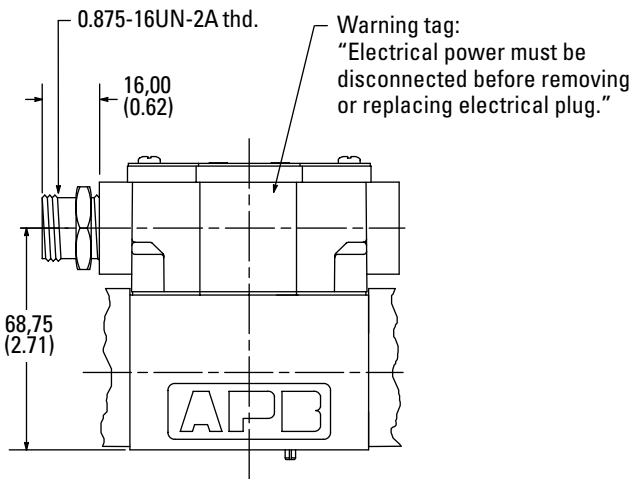

3 pin connector

Use with single solenoid valve

Key model code designations:

DG4V-3(S)-*A(L)(-**-)(V)M-FPA3W(L)

DG4V-3(S)-*B(L)(-**-)(V)M-FPA3W(L)

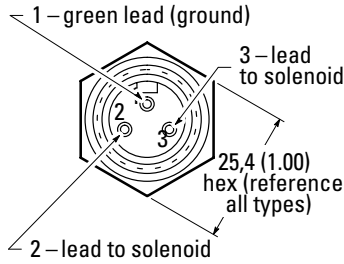

5 pin connector

Use with single solenoid valve

Key model code designations:

DG4V-3(S)-*A(L)(-**-)(V)M-FPA5W(L)

DG4V-3(S)-*B(L)(-**-)(V)M-FPA5W(L)

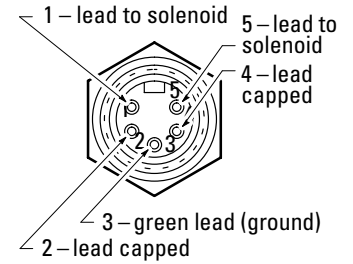

5 pin connector

Use with double solenoid valve

Key model code designations:

DG4V-3-*C/N(L)(-**-)(V)M-S4-FPA5W(L)

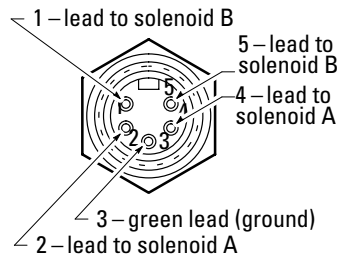

5 pin connector

Use with single solenoid valve with S3 spool position monitor switch

Key model code designations:

DG4V-3-*A(L)(-**-)(V)M-S3-FPA5W(L)

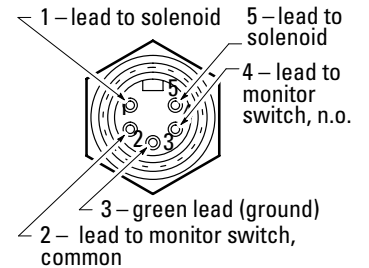

5 pin connector

Use with single solenoid valve with S4 spool position monitor switch

Key model code designations:

DG4V-3-*A(L)(-**-)(V)M-S4-FPA5W(L)

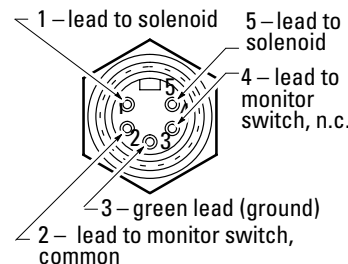

Female 3 & 5 pin connectors are available from a Daniel Woodhead Co., Brad Harrison Div. Distributor (847-272-7990)

40903 – Female connector with 12' lead for PA3 conn.

41308 – Female connector with 12' lead for PA5 conn.

These are Brad Harrison #'s.

Electrical Plugs and Connectors

DIN 43650 Connector

Cable diameter range: Ø6–10 mm (0.24–0.40)
 Wire section range: Ø,5–1,5 mm² (0.0008–0.0023 in²)
 Terminals: Screw type
 Type of protection: IEC144 class IP65, when plugs are fitted correctly to the valves with interface seals (supplied with plugs) in place.

Connector can be positioned at 90° intervals on valve by re-assembling contact holder into appropriate position inside connector housing.

Use U12 or U11 type connectors with 12 and 24V DC coils if rectification is required.

Connectors with and without indicator lights are available (order separately):

Receptacle	Voltage (AC or DC)	Part Numbers	Gray – "A" sol.	Black – "B" sol.
U1 Coils without lights	–	710776		710775
U6 Coils with lights	12-24	977467		977466
	100-125	977469		977468
	200-240	977471		977470
U11 Rectified coils with lights	12 DC	02-141358		
	24 DC	02-141359		
	98-240 VDC	02-141360		
	200-240 VDC	02-141361		
U12 Rectified coils without lights		02-141357		

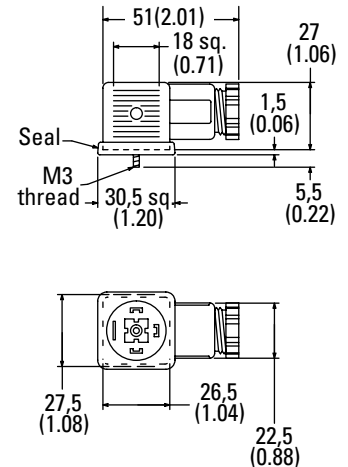

Surge Suppression Devices (For DC Valves)

Standard diode

Diode in parallel with coil. When switch (S₁) is opened, the energy stored in the coil is trapped and dissipated by the diode (D₁).

- Works only with DC voltage
- Polarity dependent
- Increase drop out time

Transzorb

Diode and Zener diode in parallel with coil. When switch (S₁) is opened, the energy stored in the coil is trapped and dissipated by the diode (D₁) and Zener diode (Z₁) and the coil resistance.

- The Zener makes exact limitation of inductive spikes.
- Works only with DC voltage
- Polarity dependent

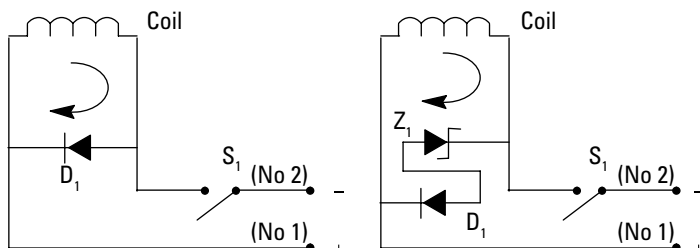

NOTE: These surge suppression devices are "Polarity Dependent." Proper biasing conditions must be met when installing/connecting a coil in a system.

Times represent cessation/application of voltage to coil versus velocity (start/stop) of a cylinder using a single solenoid, spring offset valve (time in milliseconds).

Valve Shift and Dropout Times with and without Surge Suppression

	Shift	Dropout
CETOP 3		
Do Diode	23	60
Diode Alone	23	131
Diode/Zener	23	78
CETOP 5		
Do Diode	70	50
Diode Alone	70	158
Diode/Zener	70	100

Subplates, Connection Plates and Mounting Surfaces

General description

This range of subplates and auxiliary connection plates are for use with size 3 valves. Optional BSPF or SAE/UNF pipe thread connections are available.

The subplates fall into five groups:

- Single station subplates with either side or rear entry ports for connecting to the main system.
- Multi-station manifolds having from two to six stations. The two service ports per station are arranged along one side but the pressure and tank lines are internally connected in parallel to each station.
- Tapping plates for insertion under modules or valves to provide access to service lines, e.g. for pressure gage connection.
- Cross-over plates for interconnecting two sets of service lines at the top of module stacks when directional valves are not fitted.
- Blanking plate for terminating a valve station e.g. when the station is not to be used until later.

The 2 to 6 multi-station subplates, when used together with Vickers® SystemStak™ valves, provide very compact control assemblies.

Plates having machined trapezoidal O-ring recesses are supplied complete with Viton O-rings.

On all models, the size 03 mounting face includes a drilled hole (for a location pin) in conformance with ANSI/B93.7M) and (NFPA) size 03. All Eaton size 3 valves and auxiliary plates contain a matching location pin to ensure correct orientation of the mounting faces.

DESCRIPTION AND MAXIMUM PRESSURE	FUNCTIONAL SYMBOL	MODEL CODE
Blanking plate 250 bar (3600 psi)		DGMA-3-B-1*
Crossover plate P-A, B-T 250 bar (3600 psi)		DGMA-3-C1-1*
Crossover plate P-B, A-T 250 bar (3600 psi)		DGMA-3-C2-1*
Tapping plate Ports A and B 250 bar (3600 psi)		DGMA-3-T1-1*-B DGMA-3-T1-1*-S
Tapping plate Ports P and T 250 bar (3600 psi)		DGMA-3-T2-1*-B DGMA-3-T2-1*-S
Adaptor size 05 to 03 207 bar (3000 psi)		DGAM-3-01-1*-R DGAM-3-01-1* (UNC valve mtg. bolts)
Single station subplate/manifold Rear ports P,T,A,B 250 bar (3600 psi)		DGVM-3-1*-R DGVM-3-1*-S
Single station subplate/manifold Side ports P,T,A,B 250 bar (3600 psi)		DGMS-3-1E-1*-R DGMS-3-1E-1*-S
Multi-station subplate/ manifold; side ports P,T,A1,B1,A2,B2, etc. 250 bar (3600 psi) 2 station 3 station		DGMS-3-2/3E-1*-R DGMS-3-2/3E-1*-S
Multi-station subplate/ manifold; side ports P,T,A1,B1,A2,B2, etc. 250 bar (3600 psi) 4 station 5 station 6 station		DGMS-3-4/5/6E-1*-R DGMS-3-4/5/6E-1*-S

Design number subject to change. No change of installation dimensions for designs 10 thru 19. "R" (or "B") suffix – ISO 228 (BSPF) ports and/or metric attaching bolt tappings. "S" suffix – SAE/UNC ports and/or UNC attaching bolt tappings.

Installation Dimensions

DGMA-3-B-1* Blanking Plate

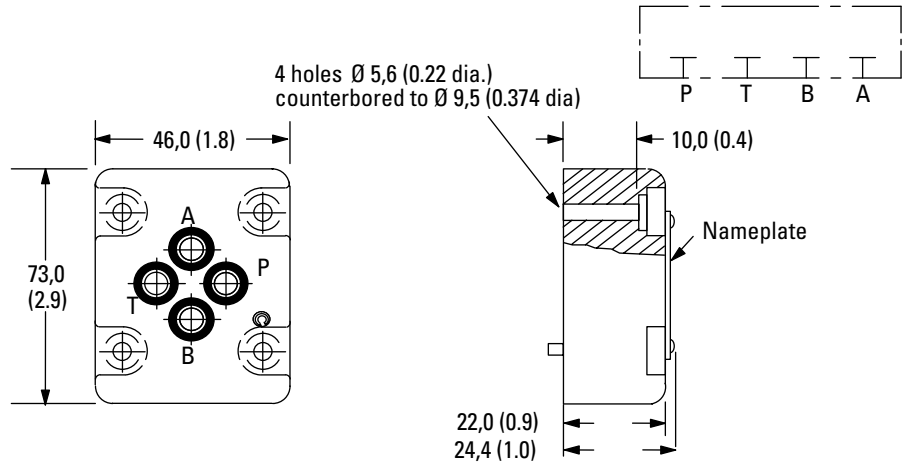

DGMA-3-C2-11 Crossover Plate

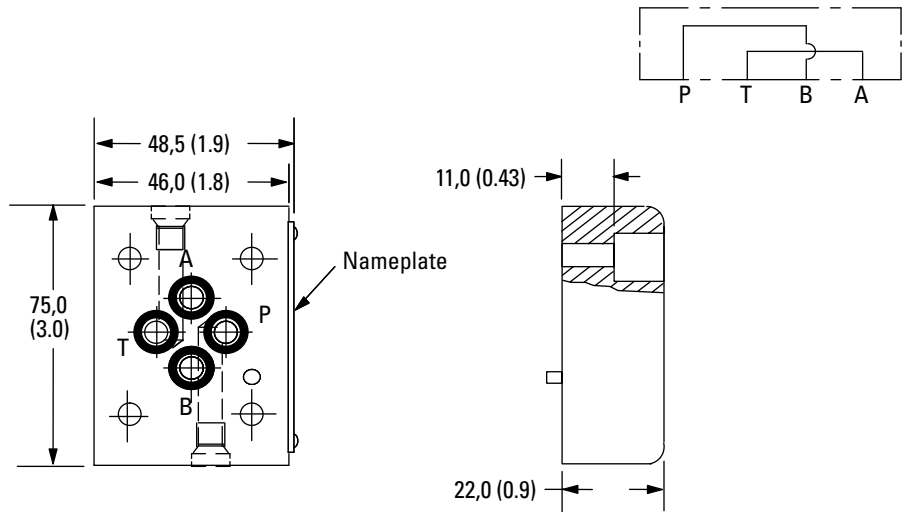

DGMA-3-T*-1*-* Tapping Plate

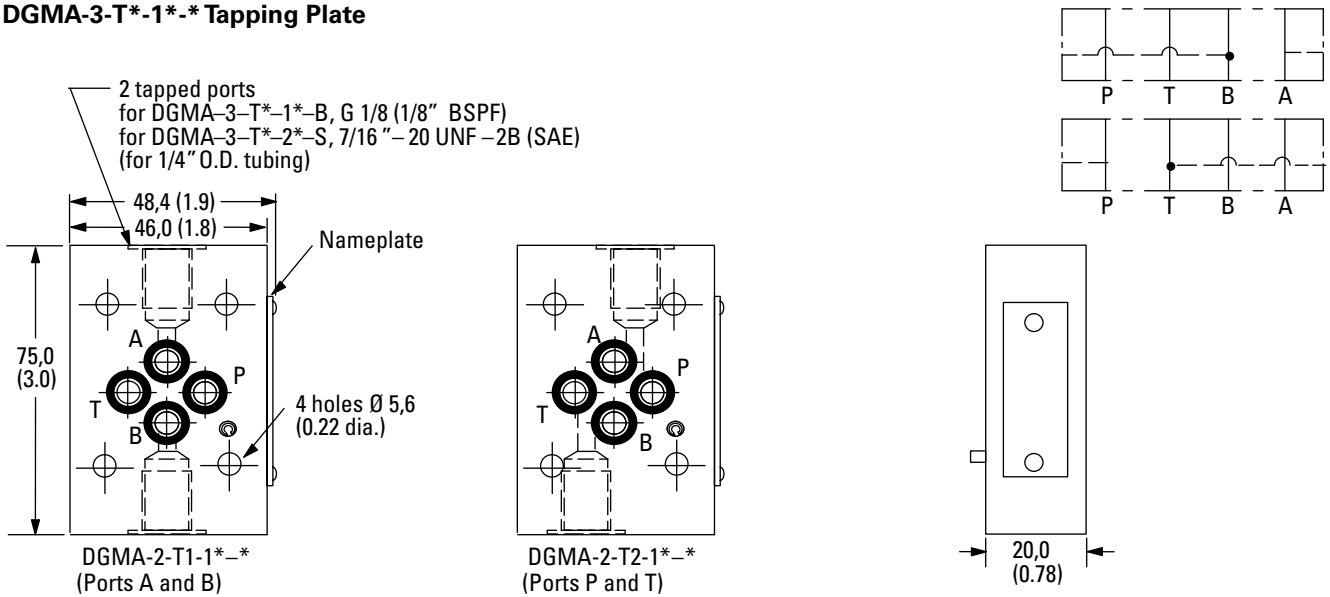

Dimensions in mm(in).

Installation Dimensions

DGAM-3-01-1*-R (Metric bolt tapping) DGAM-3-01-1* (UNC bolt tapping)

**Adaptor plate, Size 05 to 03
for pressure up to 210 bar
(3000 psi)**

Size 3 valves can frequently be used in place of size 5 valves, typically for pilot control functions, or generally where the system flow rate is within that of size 3 valves.

The DGAM-3 adaptor bolts to an existing size 5 interface and provides a size 3 mounting face for the smaller valves.

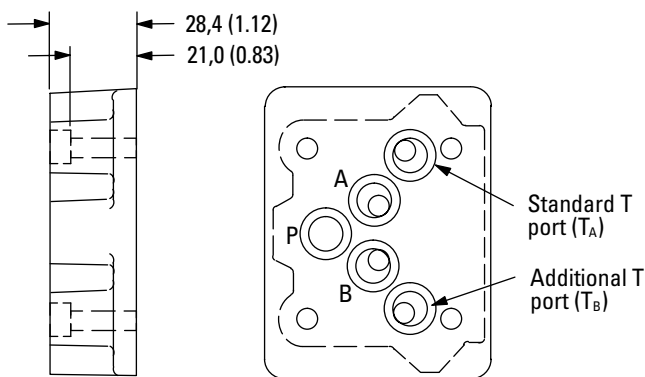
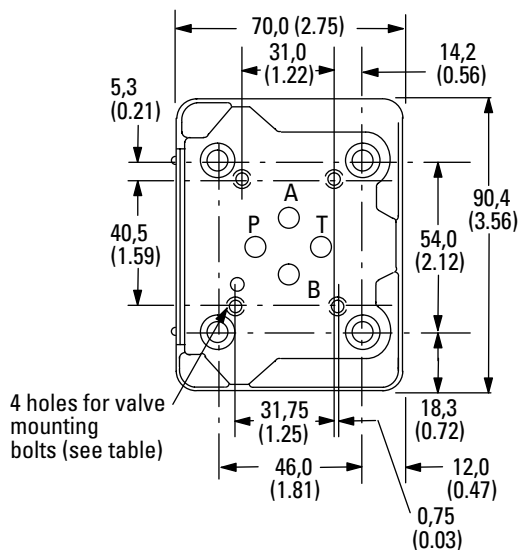
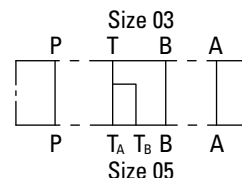

Size 03 Mounting Surface

MODEL	TAPPINGS FOR VALVE MOUNTING BOLTS
DGAM-3-01-1*-R	M5-6H x 12 (0.47) deep
DGAM-3-01-1*	#10-24 UNC-2B x 12,7 (0.5) deep

Size 05 Mounting Surface (seals included)

Adaptor is supplied complete with bolts for mounting to size 5 interface:

M6 bolts with type DGAM-3-01-1*-R
1/4" -20 UNC bolts with type DGAM-3-01-1*

Installation Dimensions

DGVM-3-1*-* DGMS-3-1E(Y)-1*-*

Single station subplate, rear and side tapped port

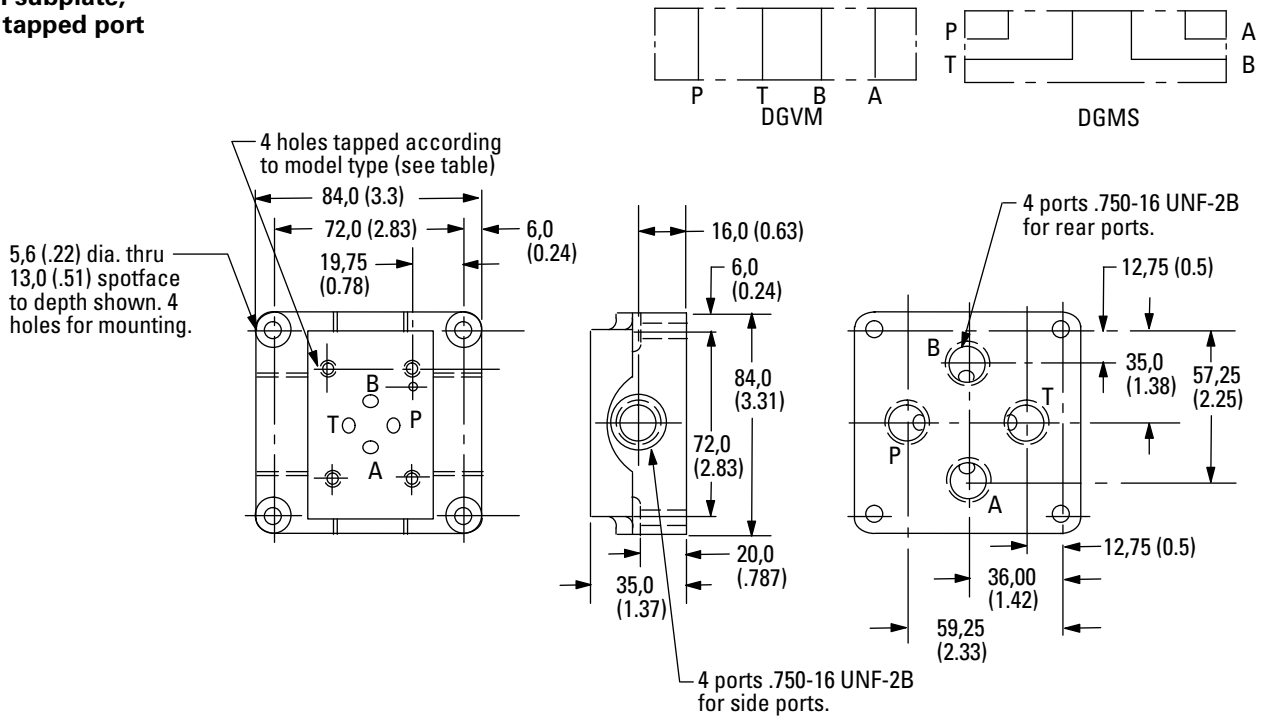

Model	Ports P, A, T, B at rear or side	Thread
DGVM-3-1*-R	Rear	G3/8 (3/8" BSPF) x
DGMS-3-1E-1*-R	Side	12,0 (0.47) deep
DGVM-3-1*-S	Rear	3/4" 16 UNF-2B x 14,3
DGMS-3-1E-1-S*	Side	(0.56) deep (SAE)
DGMS-3-1EY-1-S*	Side	5/8" 18 UNF-2B x 12,7
		(0.5) deep (SAE)

Dimensions in mm(in).

Installation Dimensions

DGMS-3-3E-1*-* Multi-station subplate (3 station shown)

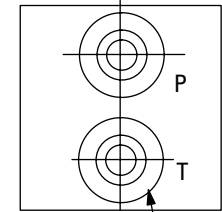
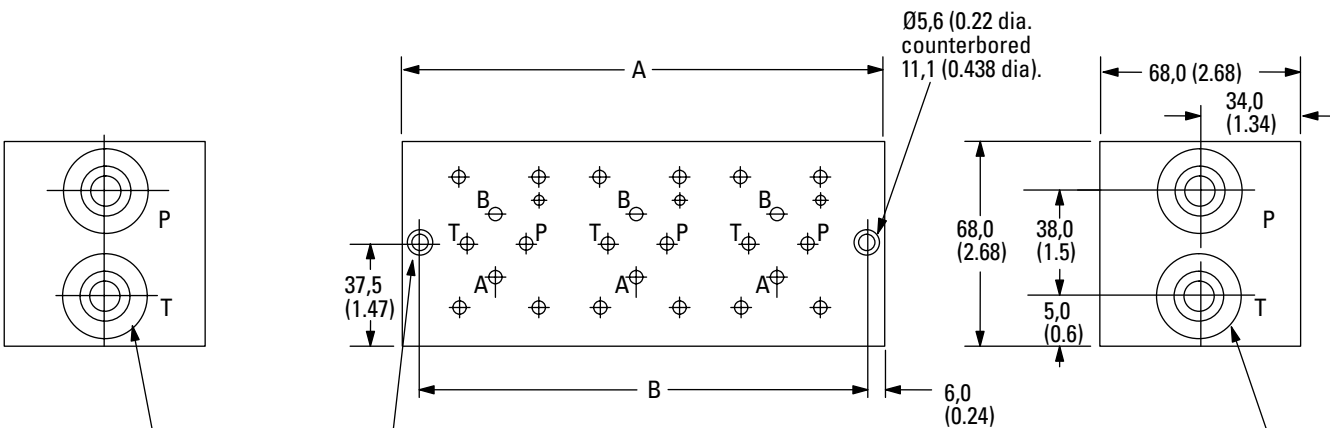
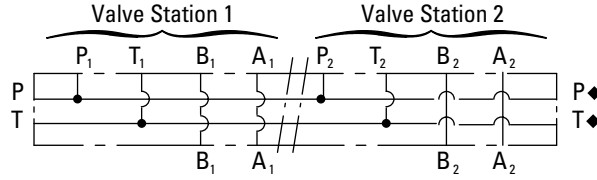

These two ports are present in 4, 5, and 6 station models. Optional in 2 and 3 station models, specify DGMS-3-2EX-1*-* or DGMS-3-3EX-1*-*

4 holes per model type
BSPF ports: M5-6H x 12,0 (0.47) deep
SAE ports: #10-24 UNC-2B x 12,5 (0.5) deep

P and T ports tapped according to model type:
DGMS-*E(X)-1*-R:
G1/2 (1/2" BSPF)
DGMA-*E(X)-1*-S:
3/4-16 UNF-2B (SAE)

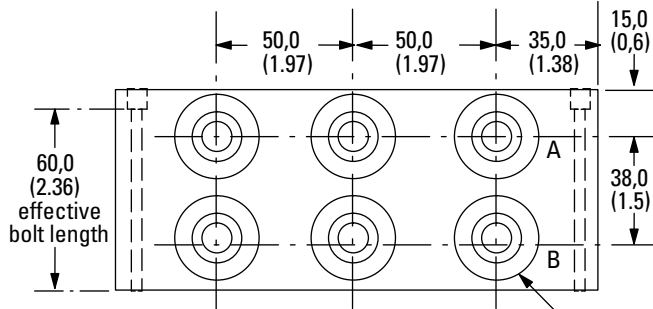

A and B ports tapped according to model type:
DGMS-*E(X)-1*-R:
G3/8 (3/8" BSPF)
DGMA-*E(X)-1*-S:
3/4-16 UNF-2B (SAE)

Model	A Dim.	B Dim.
DGMS-3-2E(X)-1*-*	121 (4.8)	108 (4.25)
DGMS-3-3E(X)-1*-*	171 (6.8)	158 (6.22)
DGMS-3-4E-1*-*	221 (8.7)	208 (8.19)
DGMS-3-5E-1*-*	271 (10.7)	258 (10.15)
DGMS-3-6E-1*-*	321 (12.7)	308 (12.12)

◆ Thru connection P and T ports on types DGMS-3-2EX-1*-* and DGMS-3-3EX-1*-*
Dimensions in mm(in).

Installation Dimensions

Mounting Surface

When a subplate is not used, a machined pad must be provided for mounting. The pad must be flat within 0,01 mm per 100 mm (0.0001" per 1") and smooth within 0,8 µm (32 µin).

The interface conforms to ISO 4401-AB-03-4A (size 03) plus location pin hole

ANSI/B93.7M (and NFPA) size 03 CETOP R35H4.2-03, plus location pin hole

DIN 24340 Form A6, plus location pin hole

Dimensional tolerance = $\pm 0,2$ (0.008) except where otherwise stated.

Prior to installing a valve, ensure that both valve and mounting surface are clean and free from burrs.

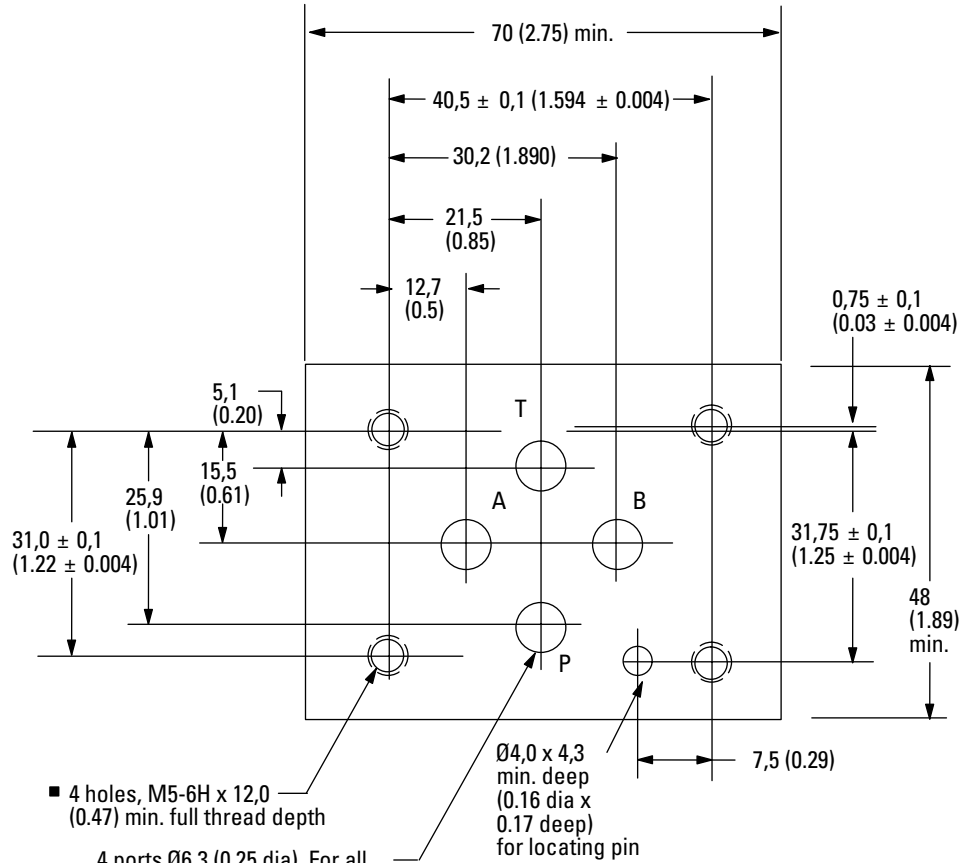

▲ ISO 4401 gives dimensions in mm. Inch conversions are accurate to 0.01" unless stated.

■ #10-24 UNC-2B optional

Dimensions in mm(in).

Mounting Bolts

INCH BOLT KITS, #10-24 UNC-2B

Size x length, in (mm)	
#10-24 x 12,7 (0.50)	BK590715
#10-24 x 19,05 (0.75)	BK466847
#10-24 x 25,4 (1.00)	BK304
#10-24 x 31,8 (1.25)	BK590716
#10-24 x 38,1 (1.50)	BK306
#10-24 x 44,4 (1.75)	BK02-156494
#10-24 x 50,8 (2.00)	BKDG3698
#10-24 x 57,2 (2.25)	BK02-139165
#10-24 x 60,3 (2.38)	BK466849
#10-24 x 69,9 (2.75)	BK870017
#10-24 x 69,9 (2.75)	BKDGFNL-694M◆
#10-24 x 76,2 (3.00)	BK02-156496
#10-24 x 79,4 (3.13)	BK466850
#10-24 x 88,9 (3.50)	BK466851
#10-24 x 95,3 (3.75)	BK869704
#10-24 x 100 (3.94)	BK466852
#10-24 x 101,6 (4.00)	BK02-156497
#10-24 x 109,5 (4.31)	BK466853
#10-24 x 120,7 (4.75)	BK466854
#10-24 x 127,0 (5.00)	BK02-156499
#10-24 x 130,2 (5.13)	BK466855
#10-24 x 133,4 (5.25)	BK02-156498
#10-24 x 139,7 (5.50)	BK466856
#10-24 x 150,9 (5.94)	BK466857
#10-24 x 160,3 (6.31)	BK466858
#10-24 x 170,0 (6.69)	BK466859
#10-24 x 177,8 (7.00)	BK890325

METRIC BOLT KITS, M5

Size x length, mm (in)	
M5 x 20 (0.79)	BK466834M
M5 x 25 (0.98)	BK465723M
M5 x 30 (1.18)	BK616452M
M5 x 40 (1.57)	BK02-156493M
M5 x 50 (1.97)	BKDG3699M
M5 x 55 (2.17)	BK986135M
M5 x 60 (2.36)	BK466836M
M5 x 70 (2.76)	BK464125M
M5 x 75 (2.95)	BK869720M
M5 x 80 (3.15)	BK466837M
M5 x 90 (3.54)	BK466838M
M5 x 95 (3.74)	BK869721M
M5 x 100 (3.94)	BK466839M
M5 x 110 (4.33)	BK466840M
M5 x 120 (4.72)	BK466841M
M5 x 130 (5.12)	BK466842M
M5 x 140 (5.51)	BK466843M
M5 x 150 (5.91)	BK466844M
M5 x 160 (6.30)	BK466845M
M5 x 170 (6.69)	BK466846M
M5 x 200 (7.87)	BK464468M

METRIC BOLT KITS, M6

Size x length, mm (in)	
M6 x 16 (0.63)	BK534564M
M6 x 20 (0.79)	BK534565M
M6 x 25 (0.98)	BK534566M
M6 x 30 (1.18)	BK534567M
M6 x 40 (1.57)	BKDG01633M◆
M6 x 45 (1.77)	BK534569M
M6 x 50 (1.97)	BK534570M
M6 x 55 (2.17)	BK534571M
M6 x 65 (2.56)	BK534572M
M6 x 70 (2.76)	BK534573M
M6 x 75 (2.95)	BK534574M
M6 x 80 (3.15)	BK638873M
M6 x 80 (3.15)	BKDGFN01637M◆
M6 x 85 (3.35)	BK978478M
M6 x 90 (3.54)	BK534576M
M6 x 100 (3.94)	BK978479M
M6 x 110 (4.33)	BK978480M
M6 x 115 (4.53)	BK534580M
M6 x 120 (4.72)	BK534581M
M6 x 140 (5.51)	BK638878M

Note:

If not using Eaton's Vickers® bolt kits, bolts must be to Grade 12.9 (ISO 898) or better.

The required bolt length should allow 0.40" (10 mm) thread engagement in the subplate/manifold block. Bolts should be torqued to 5-7 N.m (44-62 lbf. in.) with

threads lubricated. Prior to installation of DG4V-3 valve, ensure that both the face of the valve and the face on which it is being mounted (i.e subplate, manifold, SystemStak valve or plate) is as clean as possible. Do not over tighten hold-down bolts beyond recommended values.

Appendix

Spare parts data

Refer to service drawing I-3886-S for spare parts and kit information.

Seal kits

For valves with spool indicator switch, model types DG4V-3-*A-M-S*-60: kit no. 859049

For other models seal kits vary according to type of coil fitted:

For "U" type coil: kit no. 858995

For "F" type coil: kit no. 858996

Note: Each seal kit covers a variety of models and may have redundant seals for a particular model.

Mass, approx. kg (lb)

	"U" coils	"F" coils
DG4V-3 and DG4V-3S (DC)		
Single sol. valve	1,6 (3.5)	1,8 (4.0)
Double sol. valve	2,2 (4.8)	2,3 (5.0)
DG4V-3 and DG4V-3S (AC)		
Single sol. valve	1,5 (3.3)	1,6 (3.5)
Double sol. valve	1,8 (4.0)	2,0 (4.4)
Single sol. valve w/ position switch	2,0 (4.4)	2,0 (4.4)

Solenoid Coils

AC coils

Code	Voltage/ frequency	Standard performance		High performance	
		"U" type	"F" type	"U" type	"F" type
Full power coils:					
A	110V/50 Hz	02-101725	02-101730	507825	508166
B	110/120V/50/60 Hz	02-101726	02-101731	507833	508169
C	220V/50 Hz	02-101727	02-101732	507826	508167
D	220/240V/50/60 Hz	02-101728	02-101733	507834	508170
Low power coils:					
BL	110/120V/50/60 Hz	N/A	N/A	598562	698563
DL	220/240V/50/60 Hz	N/A	N/A	866455	866457

DC coils (Standard and high performance)

Code	Voltage	"U" type	"F" type	"SP1" type	"SP2" type	"KU" type
Full power coils:						
G	12V	507847	508172	02-111246	02-111166	02-140394
H	24V	507848	508173	02-111248	02-111168	02-140395
Low power coils:						
GL	12V	507855	508175	N/A	N/A	N/A
HL	24V	507852	508174	N/A	N/A	N/A

Mounting Attitude

No restrictions except for no-spring, detented models DG4V-3-*N and DG4V-3S-*N which should be mounted with the spool axis horizontal. These model types may be affected by severe vibration or shock, especially if a solenoid is not held energized.

Temperature Limits

Ambient range:
-20°C to 70°C (-4°F to +158°F)

Fluid Temperature

Fluid Temp.	Mineral oil	Water containing
Minimum	-20°C (-4°F)	+10°C (+50°F)
Maximum*	+70°C (+158°F)	+54°C (+129°F)

* To obtain optimum service life from both fluid and hydraulic system, 65°C (150°F) is the recommended maximum fluid temperature, except for water-containing fluids.

For synthetic fluids, consult fluid manufacturer or Eaton representative where limits are outside those for mineral oil.

Whatever the actual temperature range, ensure that fluid viscosities stay within the limits specified in "Hydraulic Fluids".

Fluid Cleanliness

Proper fluid condition is essential for long and satisfactory life of hydraulic components and systems. Hydraulic fluid must have the correct balance of cleanliness, materials and additives for protection against wear of components, elevated viscosity and inclusion of air.

Essential information on the correct methods for treating hydraulic fluid is included in Eaton publication 561; "Vickers Guide to Systemic Contamination Control," available from your local Eaton distributor or by contacting Eaton, Incorporated. Recommendations on filtration and the selection of products to control fluid condition are included in 561.

Recommended cleanliness levels, using petroleum oil under common conditions, are based on the highest

fluid pressure levels in the system and are coded in the chart below. Fluids other than petroleum, severe service cycles or temperature extremes are cause for adjustment of these cleanliness codes. See Eaton's Vickers® publication 561 for exact details.

Eaton products, as any components, will operate with apparent satisfaction in fluids with higher cleanliness codes than those described. Other manufacturers will often recommend levels above those specified.

Experience has shown, however, that life of any hydraulic components is shortened in fluids with higher cleanliness codes than those listed below. These codes have been proven to provide a long trouble-free service life for the products shown, regardless of the manufacturer.

Fire resistant fluids usually have higher specific gravities than oil. The specific gravity of a fluid may be obtained from its producer.

System Pressure Level

Product	bar (psi)		
	<70 (<2000)	70–207 (2000–3000)	207+ (3000+)
Vane pumps, fixed	20/18/15 1	9/17/14	18/16/13
Vane pumps, variable	18/16/14	17/15/13	
Piston pumps, fixed	19/17/15	18/16/14	17/15/13
Piston pumps, variable	18/16/14	17/15/13	16/14/12
Directional valves	20/18/15	20/18/15	19/17/14
Proportional valves	17/15/12	17/15/12	15/13/11
Servo valves	16/14/11	16/14/11	15/13/10
Pressure/Flow controls	19/17/14	19/17/14	19/17/14
Cylinders	20/18/15	20/18/15	20/18/15
Vane motors	20/18/15	19/17/14	18/16/13
Axial piston motors	19/17/14	18/16/13	17/15/12

Ordering Procedure

When placing an order, please specify full model designations of valves, subplates and kits. Refer to relevant "Model Code" sections.

This page left intentionally blank.

This page left intentionally blank.

This page left intentionally blank.



Powering Business Worldwide

© 2008 Eaton Corporation
All Rights Reserved
Printed in USA
Document No. V-VLDI-MC011-E
Supersedes GB-2072B
September 2008

Eaton
Hydraulics Operations USA
14615 Lone Oak Road
Eden Prairie, MN 55344
USA
Tel: 952-937-9800
Fax: 952-294-7722
www.eaton.com/hydraulics

Eaton
Hydraulics Operations Europe
Route de la Longeraie 7
1110 Morges
Switzerland
Tel: +41 (0) 21 811 4600
Fax: +41 (0) 21 811 4601

Eaton
Hydraulics Operations Asia Pacific
11th Floor Hong Kong New World Tower
300 Huaihai Zhong Road
Shanghai 200021
China
Tel: 86-21-6387-9988
Fax: 86-21-6335-3912